

Brüel & Kjær

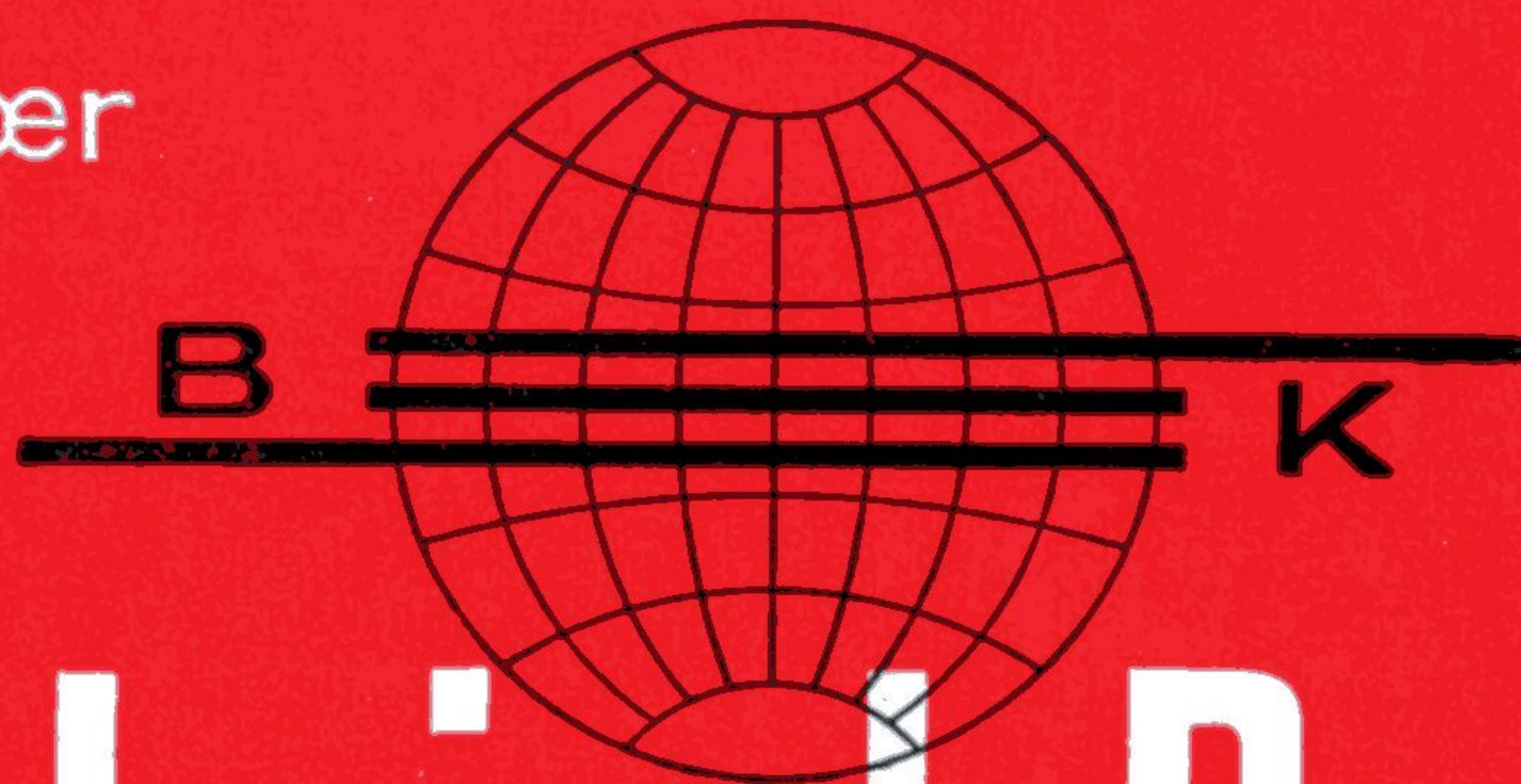

Technical Review

Teletechnical, Acoustical and Vibrational Research

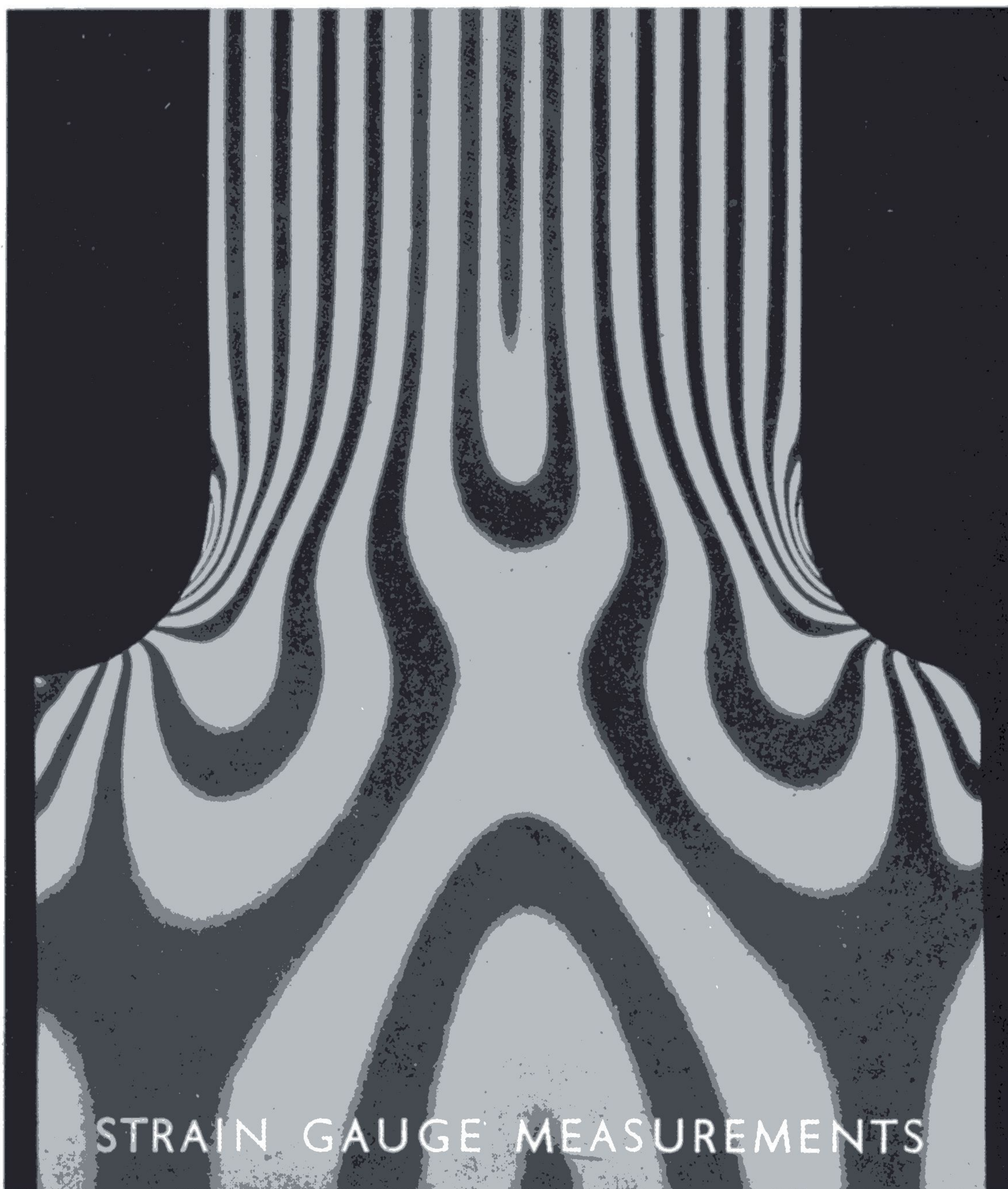

STRAIN GAUGE MEASUREMENTS



TECHNICAL REVIEW

No. 1 - 1957

Reprint October 1959

Contents.

Strain Gauge Measurements	3
Summary, English	3
Summary, French	3
Summary, German	4
News from the Factory	25

Strain Gauge Measurements

by

Jens T. Broch, Dipl. ing. E. T. H.

and

William E. Green, Grad. I. E. E.

Summary.

After a description of the resistance strain gauge itself the different types of measuring instruments are discussed and the advantage of the electronic system used in the Strain Gauge Apparatus Type 1516 described.

The problems present when actual strain investigations are to be made, and a description of the accessories available to overcome the technical and economical difficulties involved is given.

An example of static strain measurement is shown to illustrate the use of strain gauge rosettes, and the result evaluated for different types of static load attached to a complicated plate system. The stress vector is plotted for each case of loading. Other methods of determining the principal axes of stress, such as the use of photo-elasticity or stress sensitive laquers is mentioned whereafter a description of dynamic strain measurements follows, based on the different possibilities of recording and analysing the measured results. Some examples of recorded measurements are shown.

The frequency limits of dynamic strain gauging is briefly discussed.

The application of strain gauges in mechanical instrumentation is mentioned, and the fields in which strain gauges may be applied reviewed.

Sommaire.

Description de la jauge de contrainte à résistance.

Discussion sur les différents types d'instruments de mesures et les avantages du dispositif électronique utilisé dans l'appareil à jauge à résistance, type 1516.

Problèmes qui se présentent dans les recherches de contraintes et description de tous les accessoires disponibles pour couvrir les difficultés techniques et économiques.

Exemple de mesure de contraintes statiques montrant et illustrant l'utilisation des rosettes strain gauge de même que les résultats pour différents types de charges statiques liées à un système complexe. Le vecteur force est établi pour chaque cas de charge.

D'autres méthodes de détermination de l'axe principal de la force, comme l'utilisation de la photo-élasticité ou des vernis craquelants sont mentionnées après une description des mesures dynamiques de contraintes basée sur les différentes possibilités d'enregistrement et d'analyse des résultats de mesures.

Quelques exemples de résultats.

Brève discussion sur les limites de fréquence des jauges dans les efforts dynamiques.

Application des strain-gauges aux instruments mécaniques et revue des champs d'application des gauges de contrainte à résistance.

Zusammenfassung.

Nach einer Beschreibung des Widerstands-Dehnungsmesstreifens werden verschiedene Arten von Messschaltungen diskutiert und die Vorzüge des elektronischen Systems in der Dehnungstreifen-Messbrücke Type 1516 beschrieben.

Die mit der praktischen Durchführung von Dehnungsmessungen verbundenen Probleme sowie die zur Verfügung stehenden Hilfsmittel zur Überwindung technischer und wirtschaftlicher Hindernisse werden behandelt.

Ein Beispiel einer statischen Messung zeigt den Nutzen der Messtreifen-Rosetten. Für die verschiedenen Belastungsarten eines Plattensystems werden die Messergebnisse aufgeführt. Für jede Belastungsart wird der Spannungsvektor ermittelt. Andere Methoden für die Bestimmung der Spannungshauptachsen, wie die Verwendung photo-elastischer oder spröder Lackschichten werden erwähnt. Es folgt eine Beschreibung dynamischer Messungen auf der Grundlage der verschiedenen Registrier- und Analysiermöglichkeiten der Messergebnisse. Einige Beispiele für registrierte Messungen werden angeführt.

Die Frequenzgrenzen dynamischer Dehnungsmessungen werden gestreift.

Zum Schluss wird eine Übersicht über Verwendung von Messtreifen für mechanische Messeinrichtungen sowie über weitere Anwendungsgebiete gegeben.

The resistance strain gauge is the most simple, inexpensive, and generally used of all transducer devices.

The very construction of the unit makes it expendable, and the effect of its mass and stiffness upon the test-object may be discounted in the majority of cases.

The principle of operation of the gauge is as follows:

If a wire conductor of resistance R ohms, is subjected to a mechanical strain along its longitudinal axis, a change in length will result. This change in unit length, or strain, depends on the load applied, the Modulus of Elasticity of the metal, and the cross-sectional area.

From the relationship $R = \frac{A}{\rho \cdot l}$ (1)

where $R =$ Resistance of wire
 $\rho =$ Specific resistance of wire material
 $A =$ cross-sectional area of wire
 $l =$ length of wire

it is seen that a change in "l" will be accompanied by a change in "R".

Taking the logarithms of both sides of (1) and differentiating, gives:

$$\frac{\delta R}{R} = \frac{\delta \rho}{\rho} + \frac{\delta l}{l} - \frac{\delta A}{A}$$

Now, if Poisson's ratio $= \frac{1}{m}$, and if the material is homogenous and operating below the elastic limit, $\frac{\delta A}{A}$ is related to $\frac{\delta l}{l}$

Thus

$$\frac{\delta A}{A} = -\frac{2}{m} \cdot \frac{\delta l}{l}$$

$$\frac{\delta R}{R} = \frac{\delta l}{l} \left(1 + \frac{2}{m}\right) + \frac{\delta \rho}{\rho}$$

and

$$\frac{\delta R}{R} \cdot \frac{l}{\delta l} = 1 + \frac{2}{m} + \frac{\delta \rho}{\rho} \cdot \frac{l}{\delta l} \quad \dots (2)$$

$\frac{\delta R}{R} \cdot \frac{l}{\delta l}$ is obviously a property of the wire forming the gauge and is defined as the Gauge Factor.

It can be seen that this factor is not likely to be less than unity. On the other hand it is often greater than $(1 + \frac{2}{m})$. There must therefore be a change in the specific resistance of the material, or in the mechanical constants. The former is thought to be more probable. Furthermore, the actual Gauge Factor will depend upon the forming of the wire to a complete strain gauge.

The Gauge Factor of the materials used in gauge construction is usually constant up to a mechanical strain of about 0.5% (5 000 μ strain).

Important as the Gauge Factor of a material is, there are other factors of equal importance. Among these are the resistance versus temperature change relationship and the practicability of joining the gauge wire to a lead out or connecting wire without forming a thermo-couple.

A suitable compromise has been found in the cupro-nickel alloy gauges, where a very low thermal coefficient of resistivity is combined with a Gauge Factor of approx. 2.2.

Different types of resistance strain gauges are available on the market. These types differ both with respect to the process of manufacturing as well as in their form, the latter factor being dependent on the application.

The most commonly known geometrical shape is probably the one shown in fig. 1a, which is designed to measure the strain in only one direction. This type may be used whenever the principal axis of the stress is known from beforehand and is well suited for investigations on loaded bar systems.

In cases where it is desired to determine the principal axis of stress in an unknown stress field, however, the strain gauge rosette shown in fig. 1b may be used. The rosette can be made by combining a number of gauges of the type shown in fig. 1a, or pre-manufactured rosettes can be obtained directly from the manufacturers of resistance strain gauges.

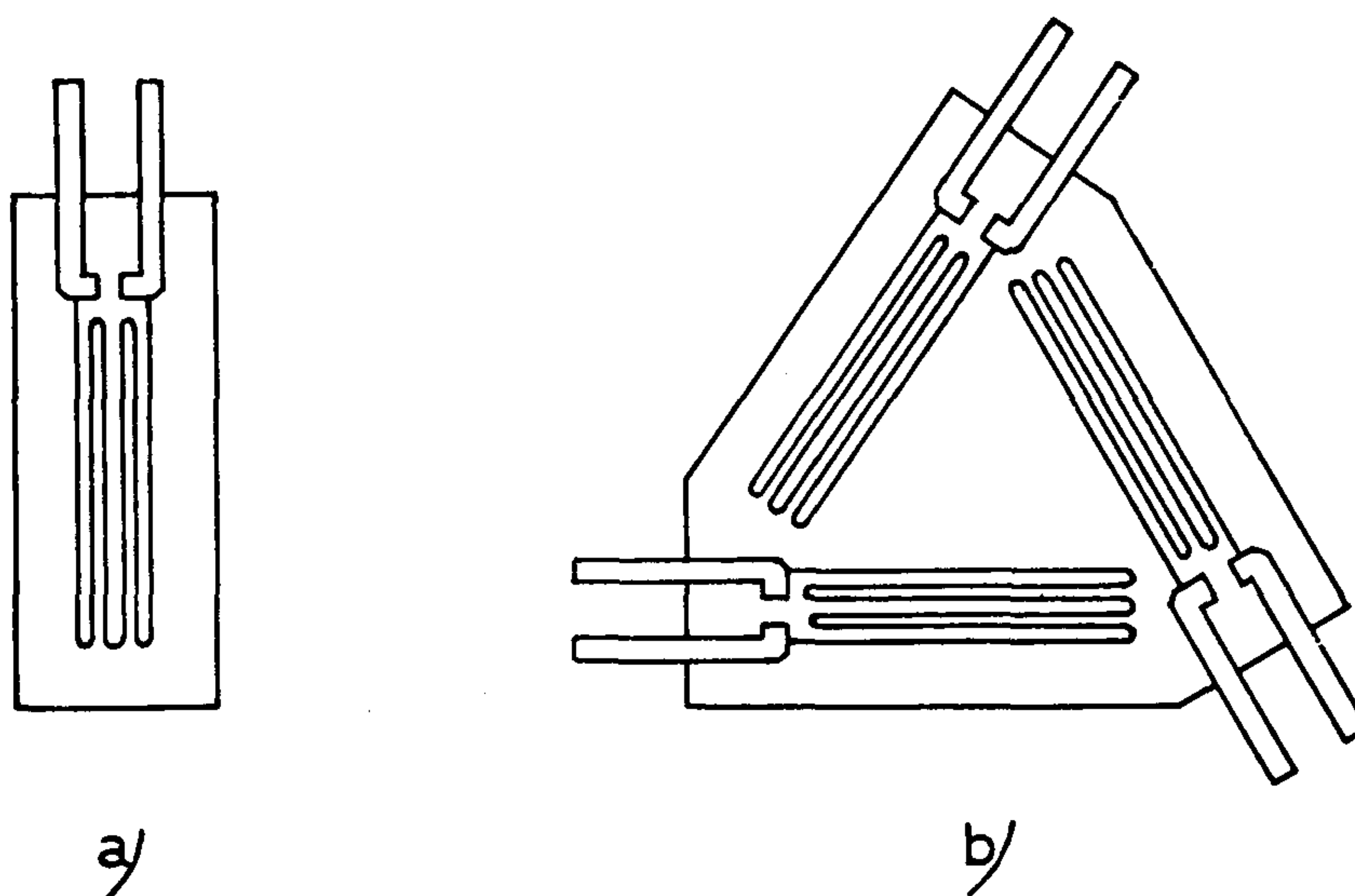

*Fig. 1. Examples of resistance strain gauges:
a) Strain gauge suitable for one dimensional strain measurement.
b) Strain gauge suitable for two dimensional strain analysis.*

Due to the physical size of the gauges, rosettes will only give accurate results when used in a stress field with a relatively small stress gradient.

The angle between the separate gauges in a strain gauge rosette is usually 45 or 60 degrees.

Because the strain in the material must be transferred to the gauge with minimum "loss" the method of affixing the gauges to the object under test must be carefully undertaken. Most strain gauge manufacturers prescribe the type of glue to be used as well as the method of affixing the different types of gauges.

It is obvious from the above description of the resistance strain gauge that the change in resistance caused by stresses in the test-object will be small.

It is therefore of the utmost importance to use a sensitive circuitry and reliable measuring equipment.

A commonly known method of measuring small resistance changes is the Wheatstone bridge in its various forms. Due to the smallness of the changes it is necessary to remove any initial out of balance from the bridge circuit before measurements are taken and this is usually achieved by one of the three circuits shown in fig. 2.

The first and second are quite simple and are called Apex balance and Shunt balance, for obvious reasons. The third system involves a double bridge, the particular advantage being that it is not necessary to have balancing elements within the measuring bridge and a large degree of initial unbalance can be accommodated without upsetting the sensitivity of the circuitry. This system is most useful when zero balance is achieved with a calibrated dial.

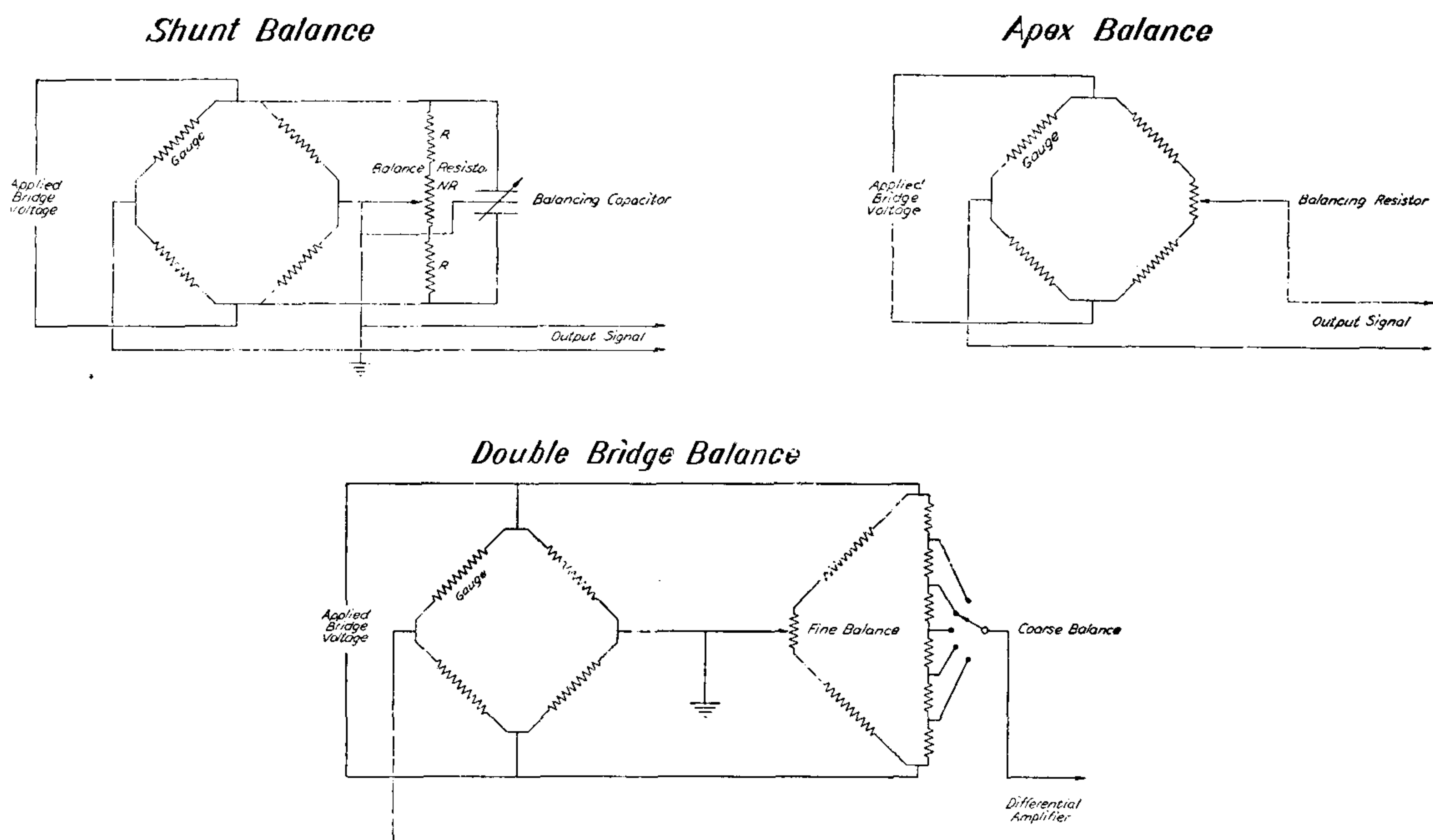

Fig. 2. Different types of bridge circuits which can be used for strain gauge measurements.

It is not necessary to use a complete bridge of strain gauges, in fact in many cases only two gauges are used, one as a strain detecting element and the other to provide temperature compensation. The other two arms of the bridge being comprised of two fixed resistors.

Energisation of the strain gauge bridge may be effected with either a.c. or d.c., each system offering its own particular advantage.

For the d.c. system may be claimed the simplicity and large capacity of the battery power supply, and the simplicity of instrumentation when only a visual indication of static deformations is required.

There are, however, disadvantages in that it is necessary to use d. c. amplifier or chopper systems if the static signal is to be amplified. However, if purely dynamic signals of above 10 c/s are being produced then the amplifier may be a. c. coupled and the scheme is relatively straight forward.

Another disadvantage of the d. c. system is that, in long term tests the effects of thermal emfs can be large compared with the signal to be measured. On the credit side is the fact that cable capacities do not effect the gauge readings, the system is however susceptible to hum pick-up.

The a. c. carrier system, although necessitating more expensive basic equipment offers several advantages. These may be enumerated as follows:

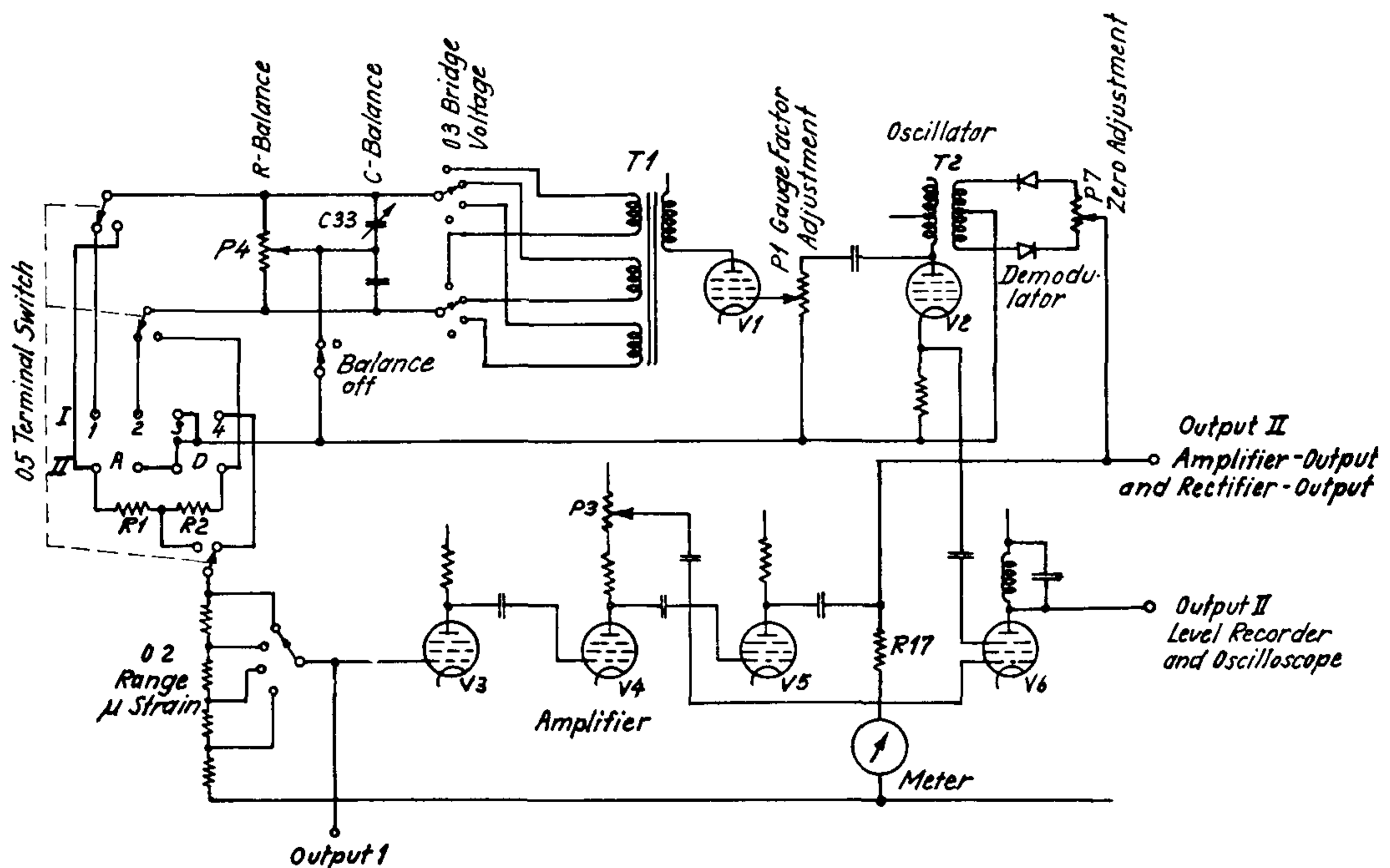

Fig. 3. Basic schematic diagram of Strain Gauge Apparatus Type 1516.

- ease of amplification
- elimination of hum and noise through the use of a phase sensitive rectifier and tuned circuit.
- no drift from thermo-couple effects.

On the other hand, however, it is necessary to balance out the reactive components of unbalance.

An example of such a system is shown in the bridge circuit of the Strain Gauge Apparatus Type 1516, see fig. 3.

This apparatus, a photo of which is seen in fig. 4, combines all the main advantages peculiar to the a. c. system.

A 3 kc/s oscillator provides the bridge supply carrier voltage. The output from the oscillator being amplified and transformer fed to the bridge circuit.

Due to the different values of Gauge Factor possessed by various strain gauges it was thought desirable to have a control in the apparatus whereby *the calibrated meter scale gives a direct reading of strain*, irrespective of the Gauge Factor of the gauge used.

In the 1516 this is achieved by having a continuously variable voltage control, between the oscillator and the bridge voltage output stage.

Provision is made for two distinct types of bridge connection, i.e. with the full strain gauge bridge external to the apparatus or, with only two external strain gauges and two internal fixed resistors.

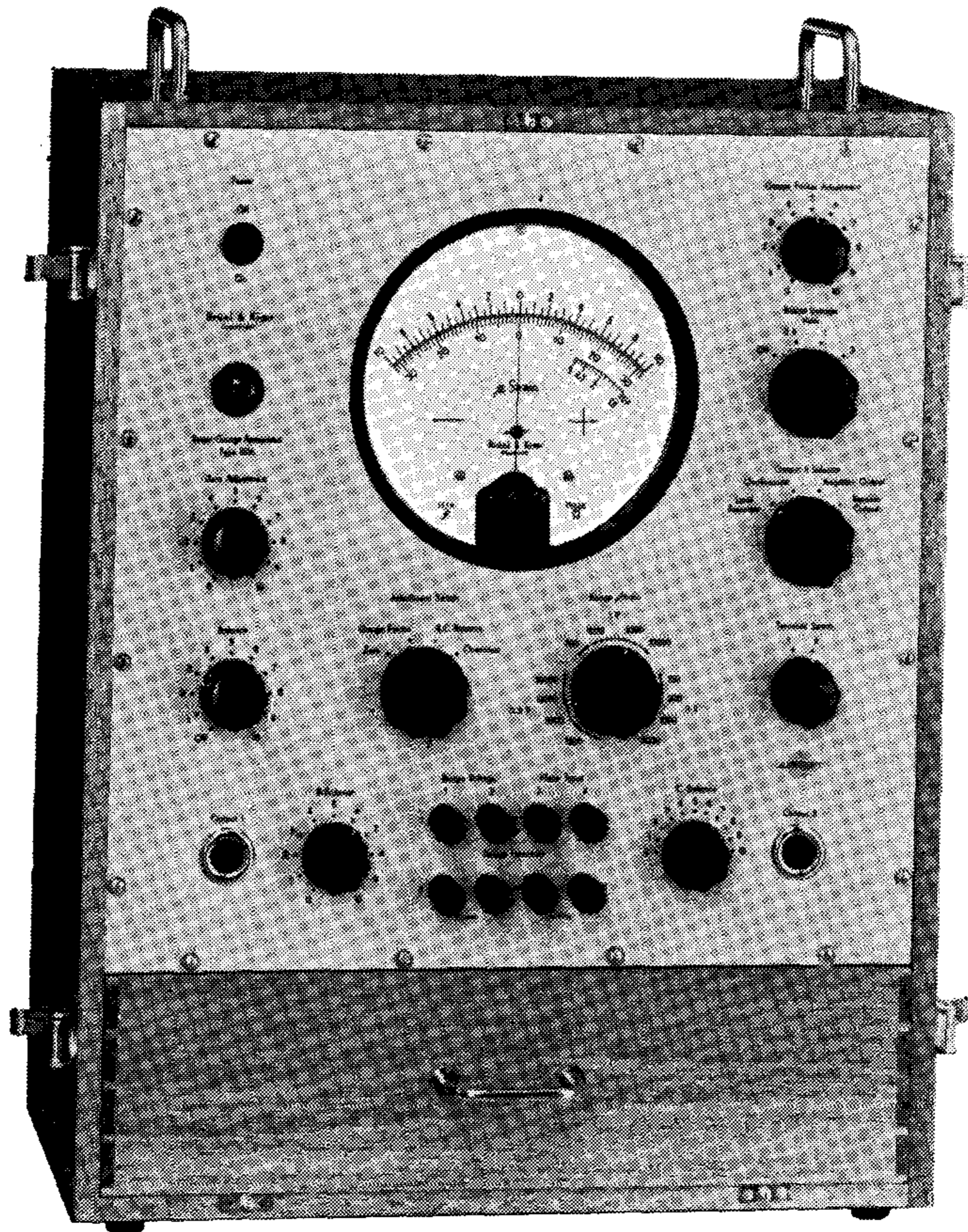

Fig. 4. Photo of the Strain Gauge Apparatus Type 1516.

The shunt balancing components make possible the resistive and capacitive balancing of the bridge circuit.

Bridge voltages variable in steps of 10 db and an input attenuator also working in steps of 10 db, give a strain range coverage, using one active gauge, of from 100 μ strain—30 000 μ strain, for full scale meter deflection.

The over-all gain of the amplifier is about 80 db from input to meter rectifier.

Although simple strain gauge measurements can be carried out by connecting the gauge directly to the Strain Gauge Apparatus and use a fixed resistor having the same resistance value as the strain gauge itself to balance the bridge, this type of measurement will scarcely be found in practice.

First of all the change in gauge resistance with temperature should be compensated for. This is normally done by employing a "dummy" gauge, and arrange the bridge circuit as shown in fig. 5.

The "dummy" gauge is fastened onto an unstrained slip of the same material as the test object, the slip being kept close to the measuring point to ensure that both gauges experience the same temperature cycling.

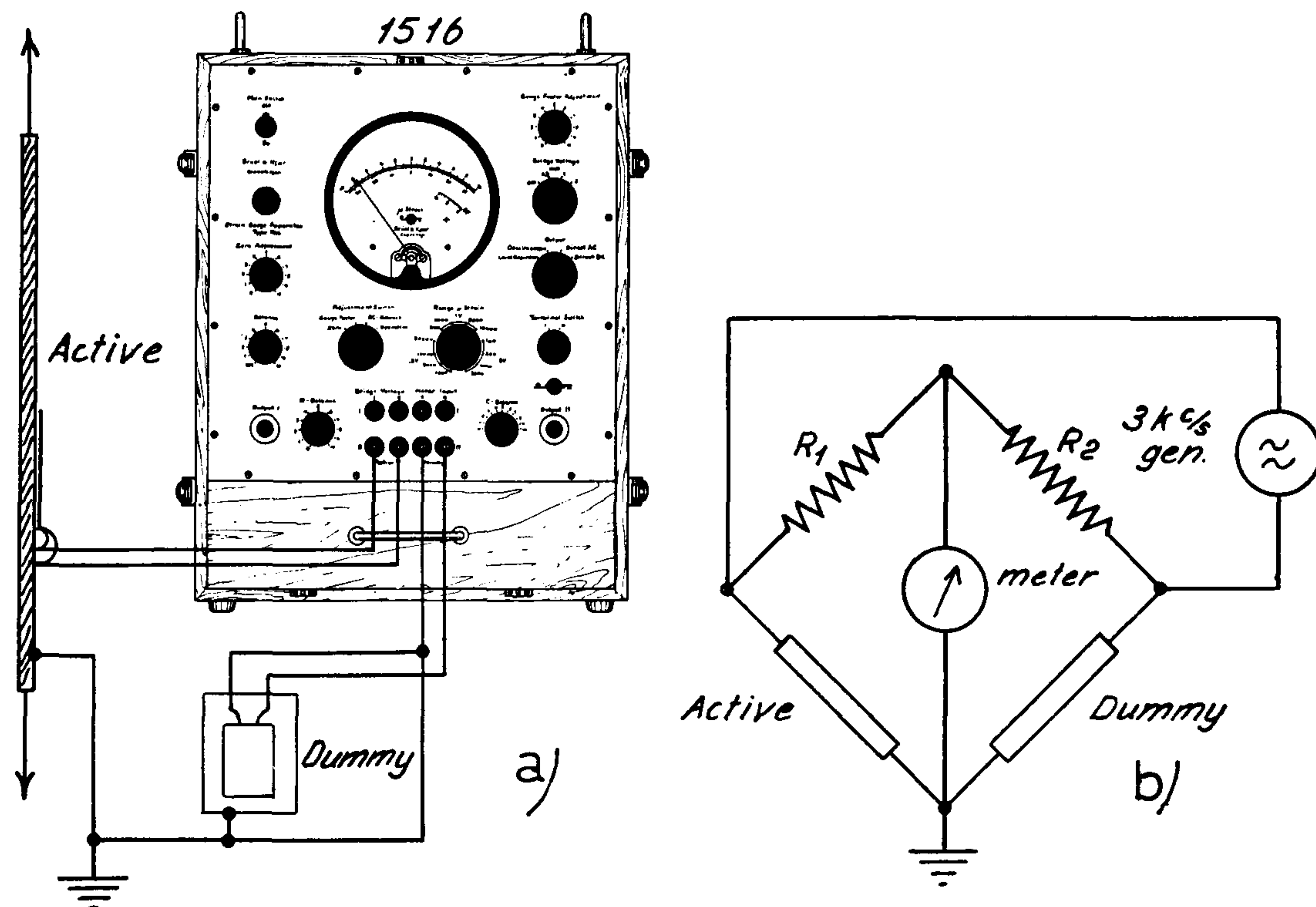

Fig. 5. Measurement of tensile strain using one active and one dummy gauge.
 a) Measuring arrangement.
 b) Bridge connection.

Secondly it is not always possible to place the instrumentation close to the measuring point, whereby the resistive and capacitive effect of long connecting wires in the gauge leads cause inaccuracy in the measured result.

Furthermore, when strain investigations on complicated structures are made the use of only one measuring point per Strain Gauge Apparatus is a most uneconomical proposition.

Several Accessories have therefore been designed to the Type 1516 to meet the requirement, for an accurate, quick and economic measuring technique.

In fig. 6 is shown the Balancing Unit Type 1530, by means of which it is possible to take accurate measurements even if it is necessary to have a great distance between the measuring point and the Strain Gauge Apparatus. The

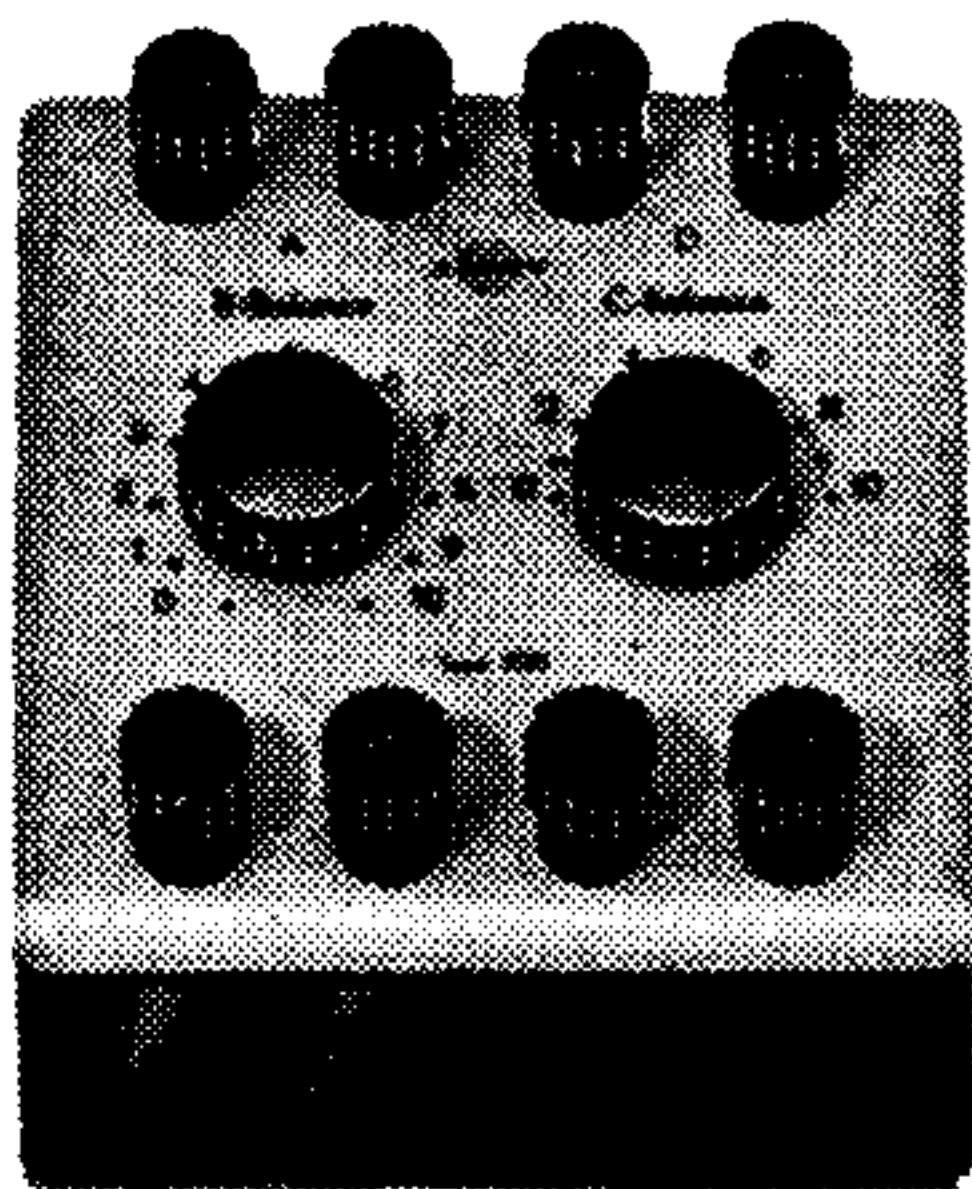

Fig. 6. Photo of the Balancing Unit Type 1530.

only factors which have to be taken into account are the voltage drop in the connecting cables and the effect of capacitive input to the amplifier in Type 1516. A typical measuring arrangement is shown in fig. 7.

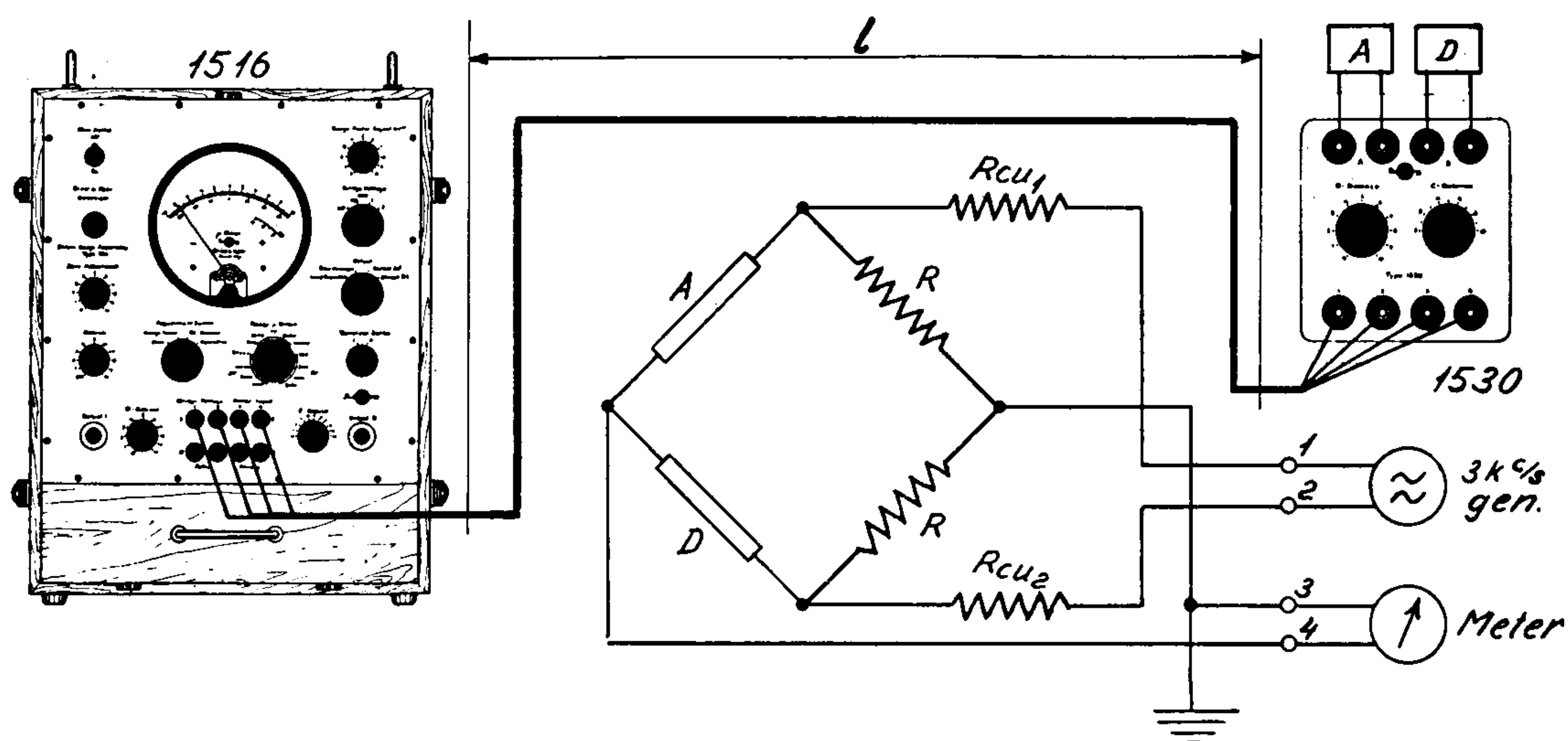
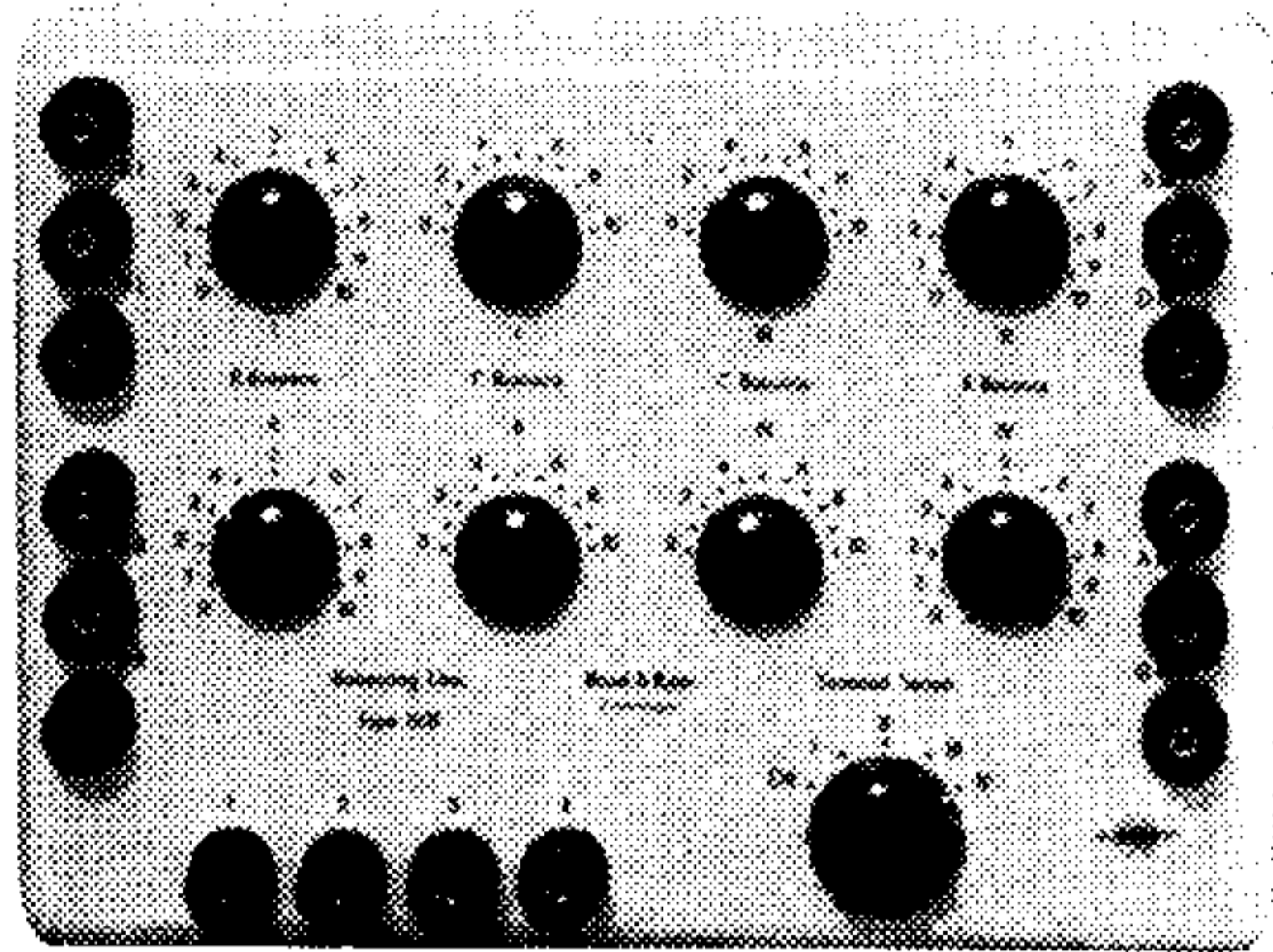
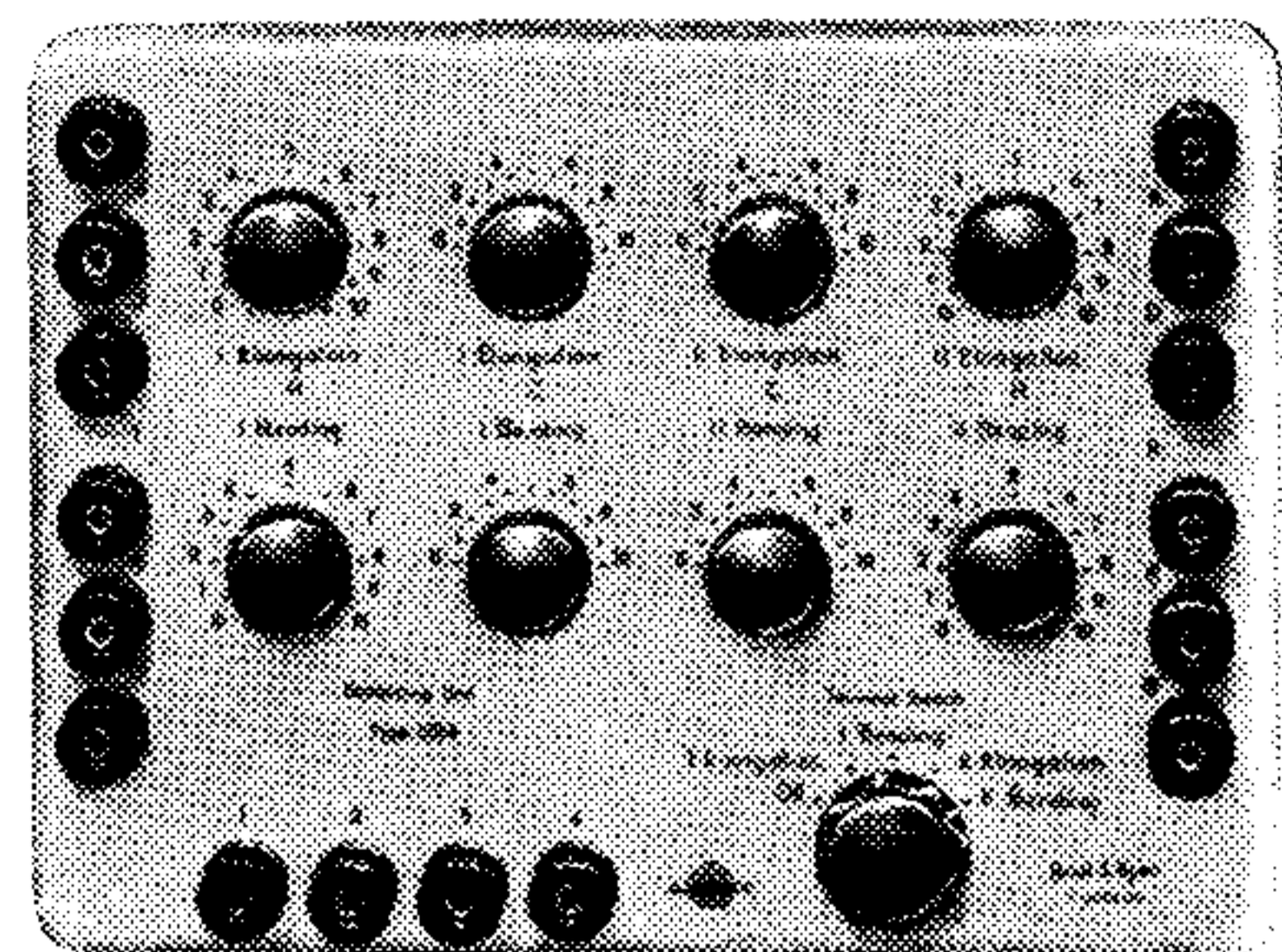

Fig. 7. Use of Balancing Unit Type 1530.

To enable more measuring points to be fed to a single unit of the Type 1516 several multipoint panels are available, such as Balancing Unit Type 1531 (4 measuring points, manual switching), Balancing Unit Type 1534 (specially designed for the measurement of combined bending and elongation in loaded bar-systems). Automatic Selector Type 1536 and Twenty Point Panel Type 1537. Type 1536 may be combined with two instruments of the Type 1537 to form a complete 50 point panel with automatic, or manual, switching between the measuring points. See fig. 8 and 9.



a) Type 1531.



b) Type 1534.

Fig. 8. Photo of the Balancing Units Type 1531 and Type 1534.

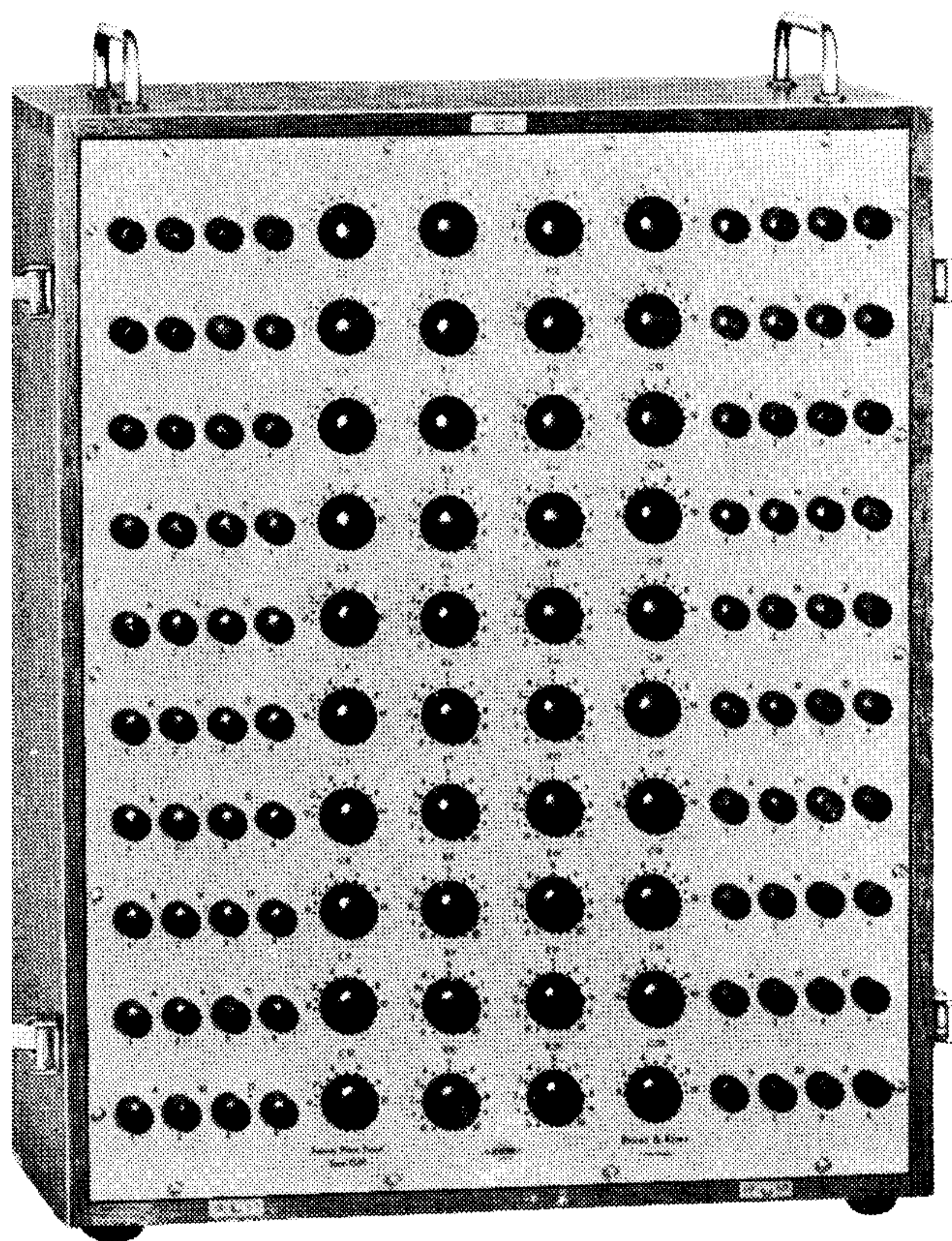

Type 1537.

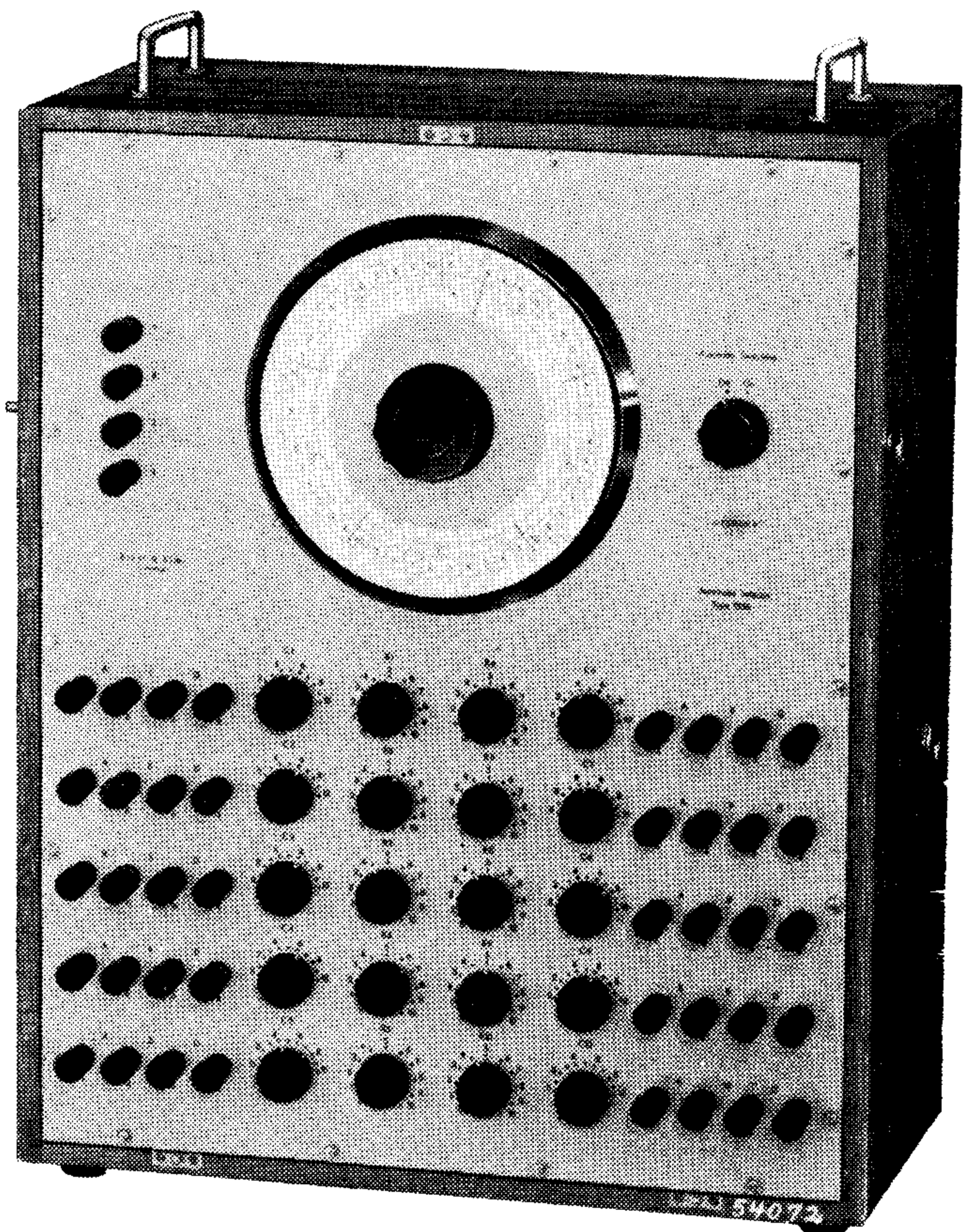

Type 1536.

Fig. 9. Photo of the Automatic Selector Type 1536 and Twenty-Point-Panel Type 1537.

The result of static strain measurements may be displayed directly on the center zero indicating meter in the Strain Gauge Apparatus.

The meter circuit contains a phase sensitive rectifier so that *elongation or compression is indicated directly as positive or negative meter deflection.*

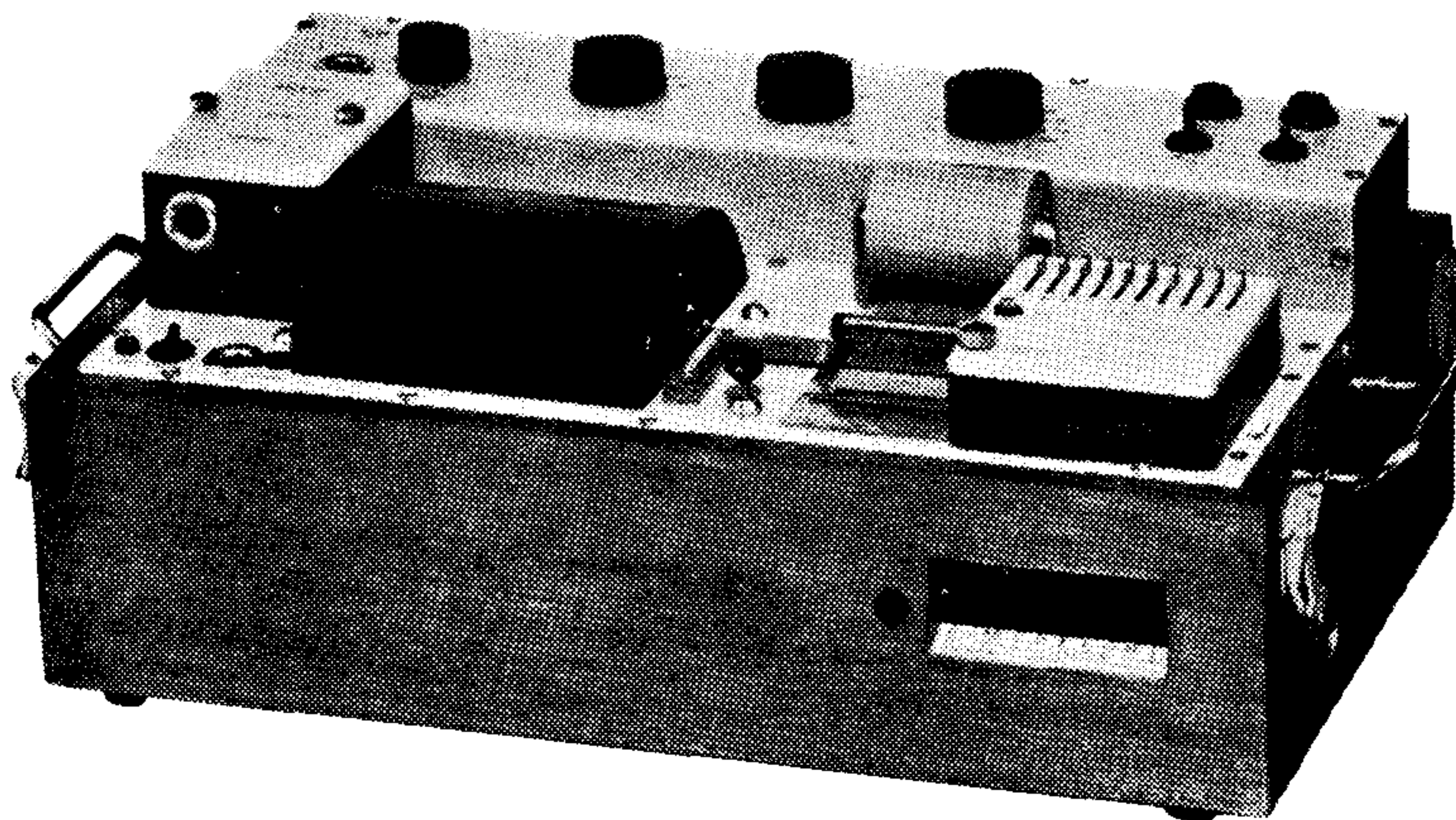

Fig. 10. Photo of the Level Recorder Type 2304.

Slowly varying dynamic strains may also be displayed on the meter, the maximum frequency which the meter can follow being dependent upon its dynamic qualities. In Type 1516 a correct peak value for full meter deflection will be obtained for frequencies lower than approx. 1 c/s.

In many applications it is desirable to record the measured result on a graphic level recorder or display it on the screen of an oscilloscope.

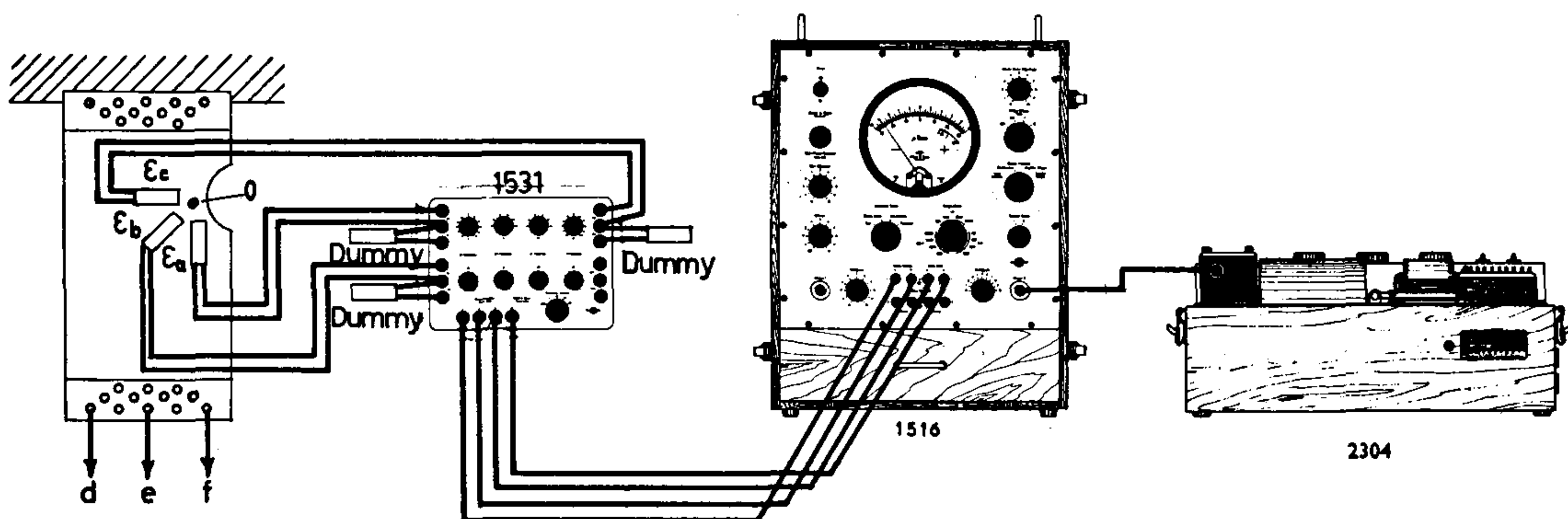

Fig. 11. Measuring arrangement for determining the principal strains in a structure when static loads are applied at different points.

Different output facilities are therefore provided in the Strain Gauge Apparatus Type 1516. If it is desired to use external indicating instruments instead of the built-in meter, the output from the 1516 amplifier is fed to a socket on the front panel of the instrument via an output selector.

A measuring arrangement employing the Balancing Unit Type 1531, the Strain Gauge Apparatus Type 1516 and the Level Recorder Type 2304 is

shown in fig. 11, and to illustrate the use of these instruments in static strain measurements a thin Al-plate is investigated.

The measurements were carried out with loads fixed alternatively at the points marked d, e and f, and the direction and magnitude of the stress at the point 0 determined from strain-rosette measurements.

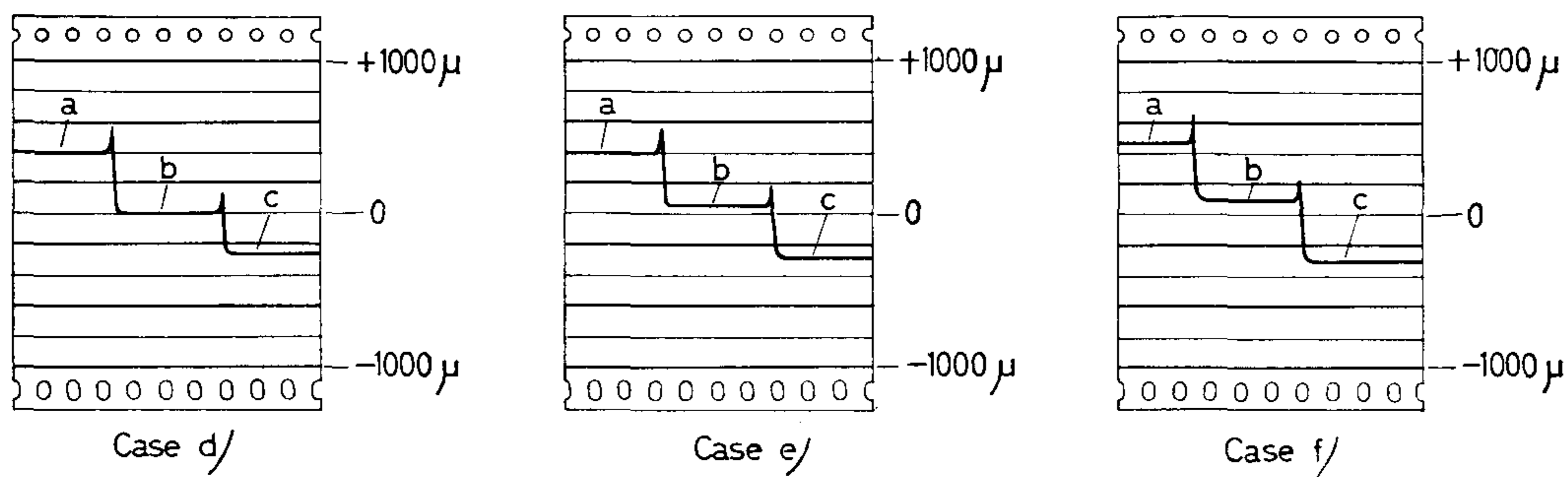

Fig. 12. Recordings obtained from measurements taken with the arrangement shown in fig. 11.

- d) A static load of approx. 3 kg is applied at point d.
- e) The same load is applied at point e.
- f) The load is applied at point f.

The applied load was approx. 3 kg in all three cases, and the measured results recorded on the Level Recorder. Fig. 12 shows the recordings obtained and the principal axis as well as the magnitude of the stress are readily found

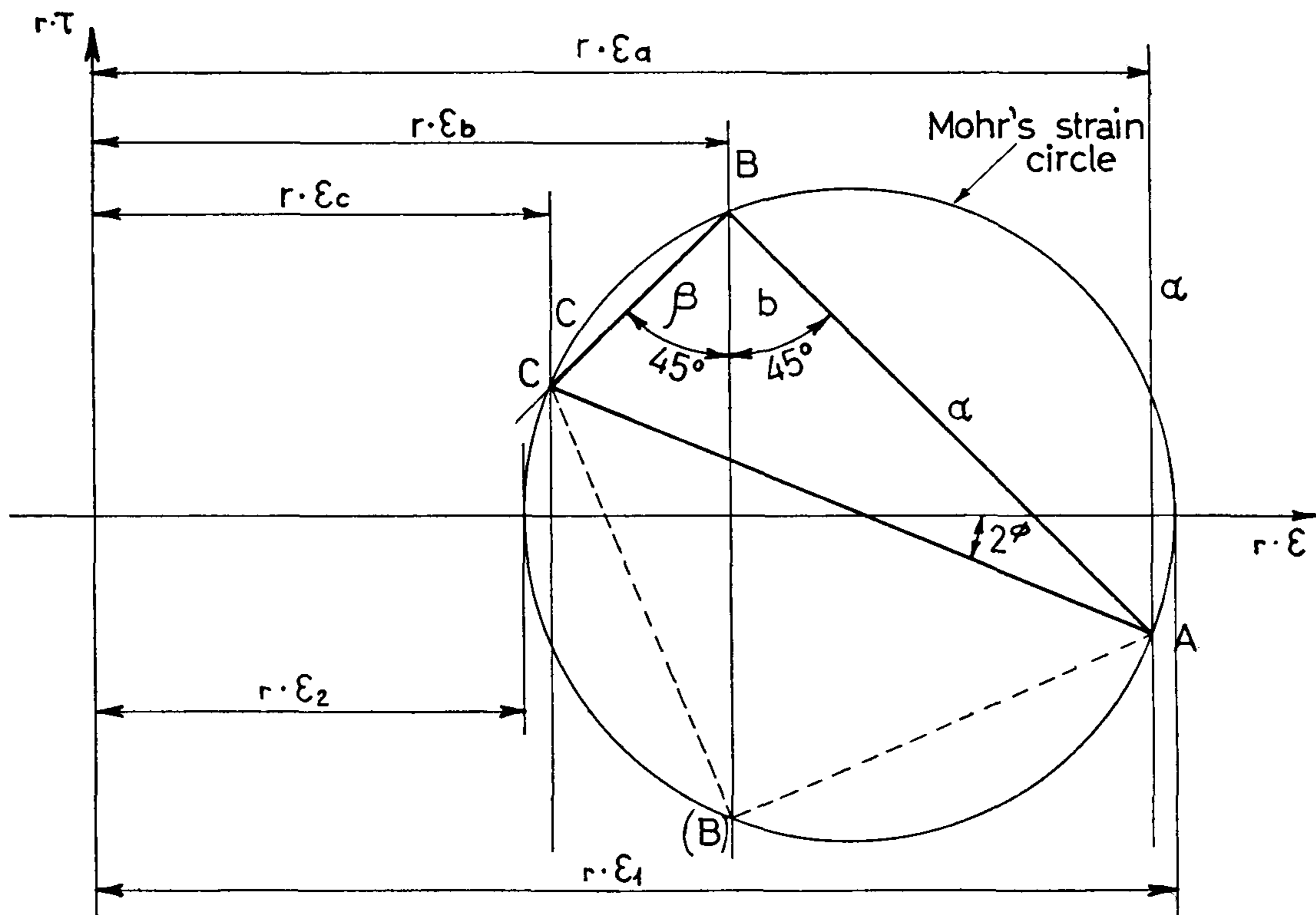

Fig. 13. Graphical method for the evaluation of principal strains when a strain gauge rosette of $0 - 45^\circ - 90^\circ$ is applied.

in each case. Several numerical and graphical methods have been developed for this purpose, and a convenient semigraphical method based on the construction of Mohr's strain circle will be described below.

A vertical line is drawn, and parallel to it lines are drawn at distances related to the actually measured strains ϵ_a , ϵ_b and ϵ_c as shown in fig. 13.

From a point B, arbitrarily chosen on the line b, angles of 45° are marked and the lines α and β drawn. The points of intersection between β and c as well as between α and a are called C and A, respectively.

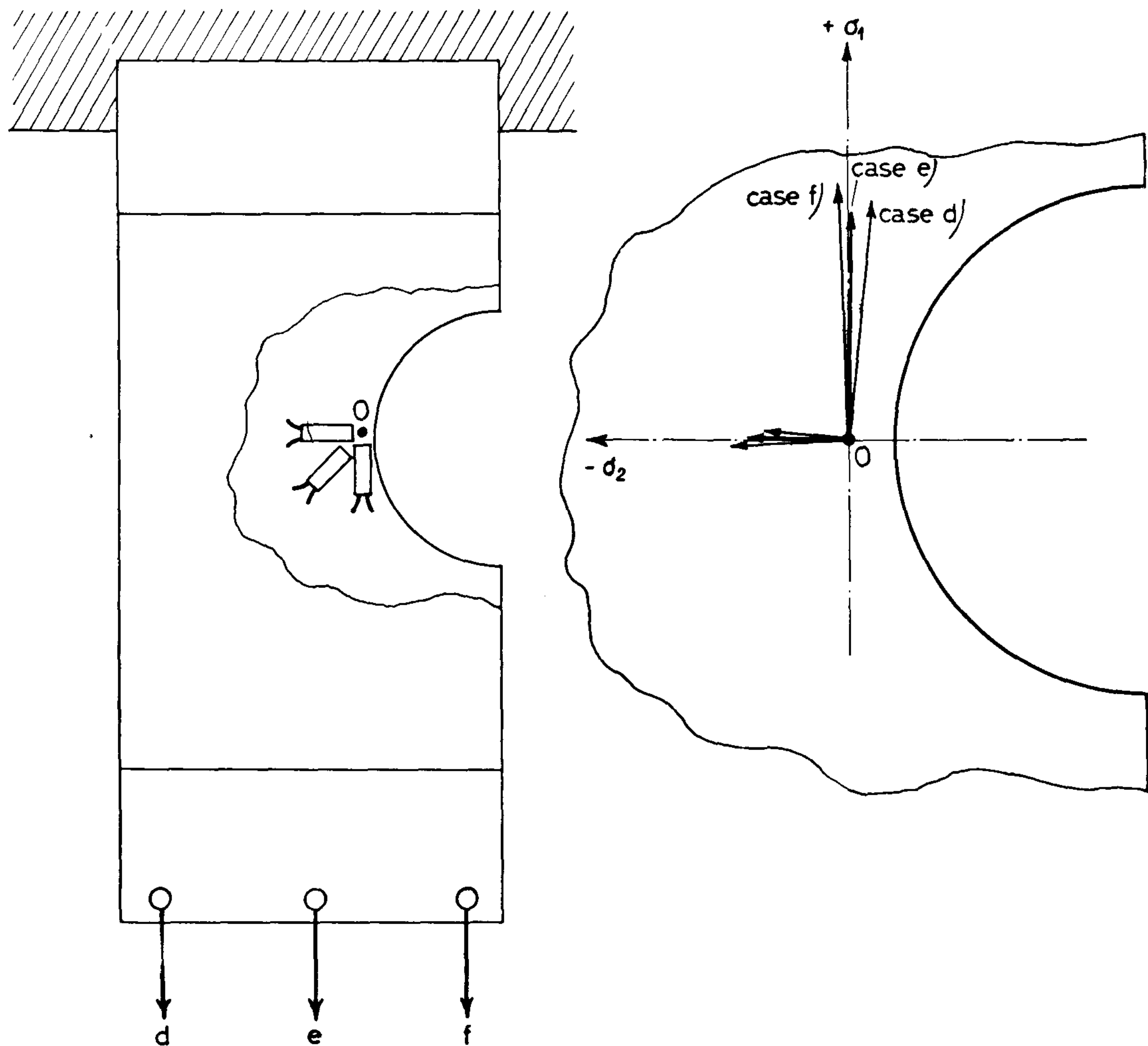

Fig. 14. Principal stresses in the structure evaluated from measurements of the type shown in fig. 11.

A, B and C are three points on Mohr's circle which can then be drawn. The principal axis of strain, which coincide with the principal axis of stress, now form an angle φ with the strain gauge marked a.

The magnitude of the principal stresses can be calculated from the formula

$$\sigma_1 = \frac{m^2 \cdot E}{m^2 - 1} \left(\varepsilon_1 + \frac{1}{m} \cdot \varepsilon_2 \right)$$

and

$$\sigma_2 = \frac{m^2 \cdot E}{m^2 - 1} \left(\varepsilon_2 + \frac{1}{m} \cdot \varepsilon_1 \right)$$

where $\frac{1}{m}$ = Poisson's ratio and E is the modulus of elasticity.

The result of the above calculations for the case being investigated is shown in fig. 14, the direction and magnitude of the stress for the different cases d, e and f being indicated on the figure.

In many cases only one active strain gauge is used for each measuring point on the structure, the direction of the principal stresses being known beforehand. These directions may be determined from photo-elastic investigations on structures of the same shape, or from experiments employing stress sensitive laquers. However, the most accurate and convenient method capable of measuring the magnitude of the actual strain, in practice, may be taken to be the strain gauging method using resistance strain gauges.

As previously mentioned strain measurements on complicated structures require measurements to be made at several points on the structure, even if the principal axis of stress is known. In such cases use should be made of the multipoint panels Type 1536 and 1537, and in fig. 15 a slip of recording paper showing the result of multipoint measurements recorded on the Level Recorder Type 2304 is given.

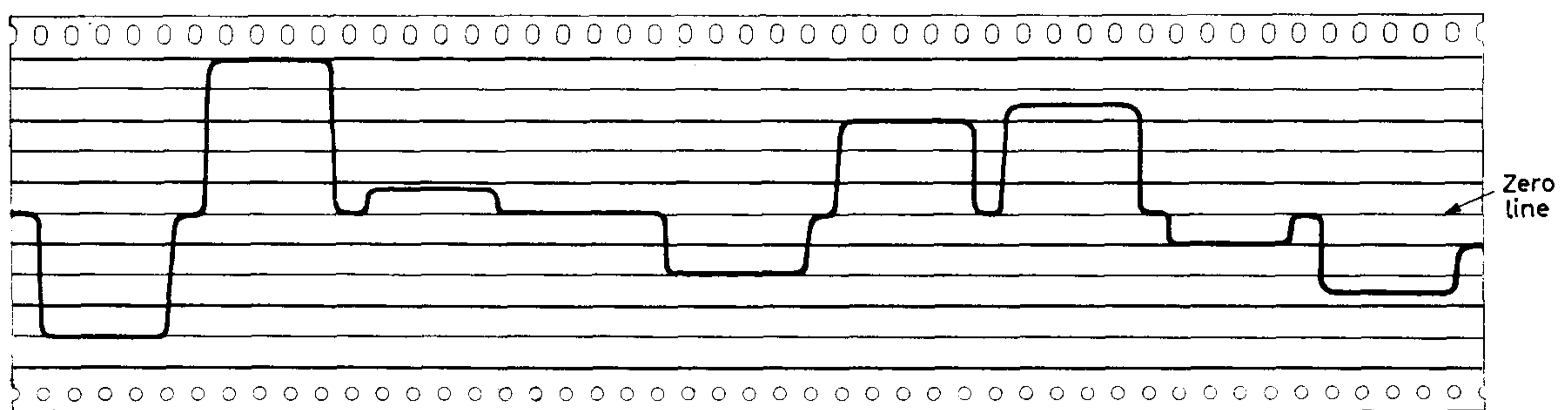

Fig. 15. Recording of the strain at 9 different points on a complicated structure employing the Automatic Selector Type 1536 in connection with the Strain Gauge Apparatus Type 1516 and the Level Recorder Type 2304. Note the check on the zero point between consecutive measurements.

So far the basic procedure to be employed when static strain measurements are taken have been described.

Another type of strain measurement, which is probably still more important than static measurements, is the measurement of dynamic strain. A theoretical calculation of dynamic strain in various parts of a composite structure is extremely difficult and is possible only in simple cases. Actual measurements

are therefore of indispensable value. As a typical example of where dynamic strain measurements are important may be mentioned the problem of finding the max. stress in a railway bridge when differently loaded trains are passing at different speeds.

Depending upon the frequency of the dynamic stress forces different measuring methods can be employed.

1) When the frequency is of the order of some few cycles per second, the same measuring arrangement as used for static strain measurements can be employed, and the result displayed in the Level Recorder Type 2304. However, the mechanical writing system of the Level Recorder can only follow relatively slowly varying phenomena.

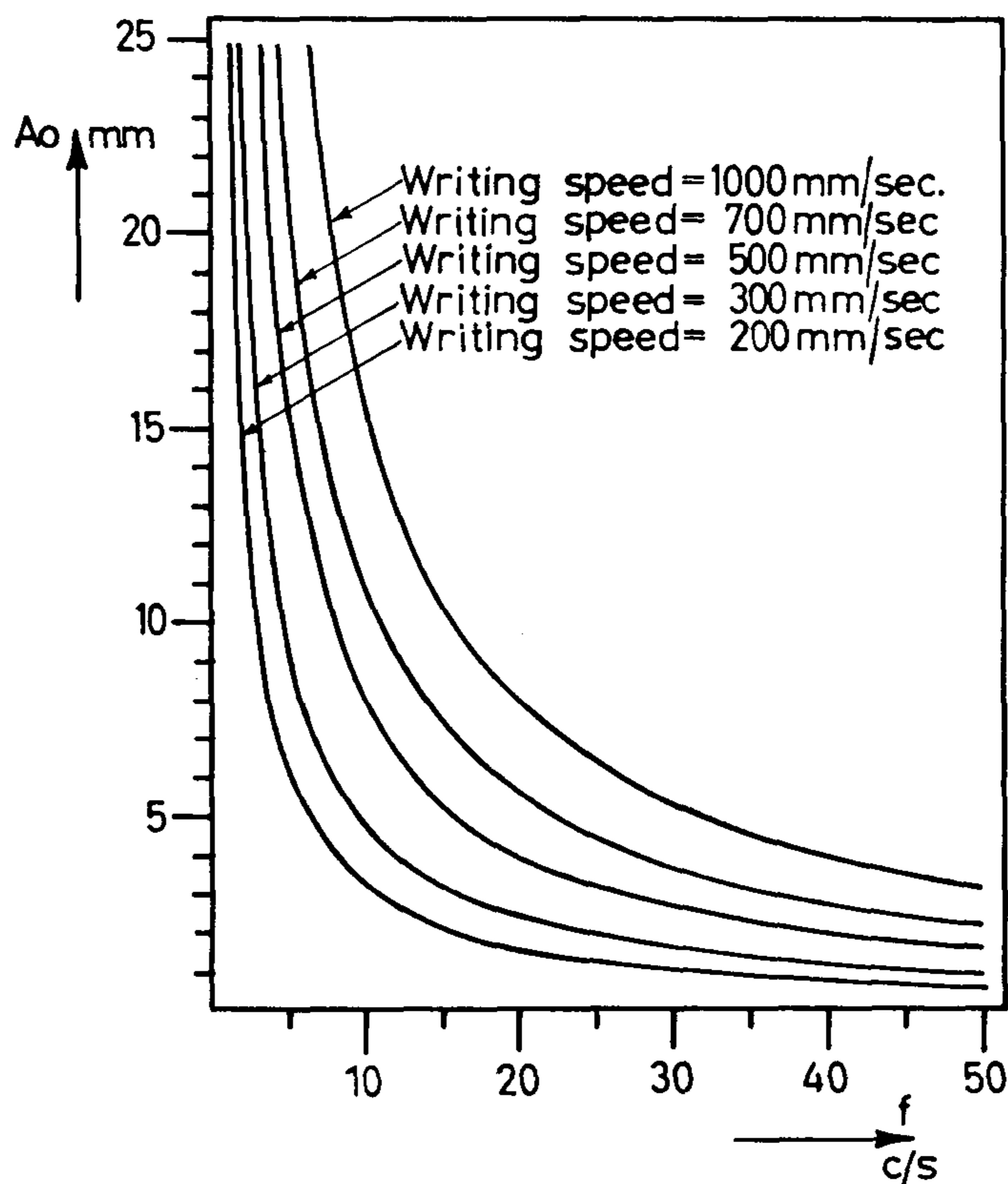

Fig. 16. Curve showing the frequency dependency of the max. amplitude which can be correctly recorded for different "Writing Speed" settings on the Recorder.

The frequency dependency of the max. amplitude which can be correctly recorded for different "Writing Speed" settings on the Recorder is shown in fig. 16.

A typical example of a damped vibration recorded on the Level Recorder Type 2304 is shown in fig. 17.

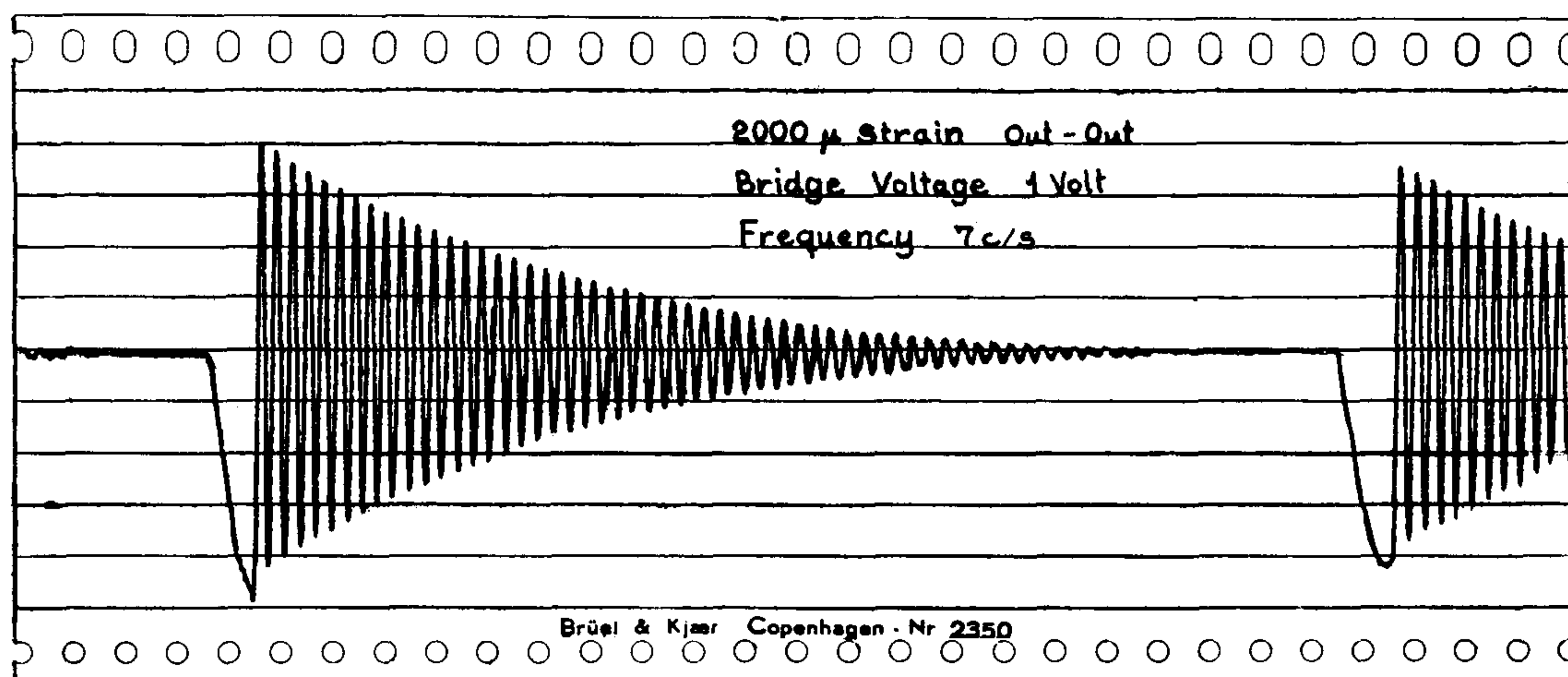

Fig. 17. Damped vibration recorded on the Level Recorder Type 2304.

2) Dynamic Strains of frequencies between 10 c/s and approx. 200 c/s can be measured with the same strain gauge equipment as shown in fig. 7. The measured result, however, should in this case be displayed on the screen of an oscilloscope.

A typical measuring set-up and the signal obtained on the oscilloscope screen is shown in fig. 18. The signal will, of course, be of the modulated type,

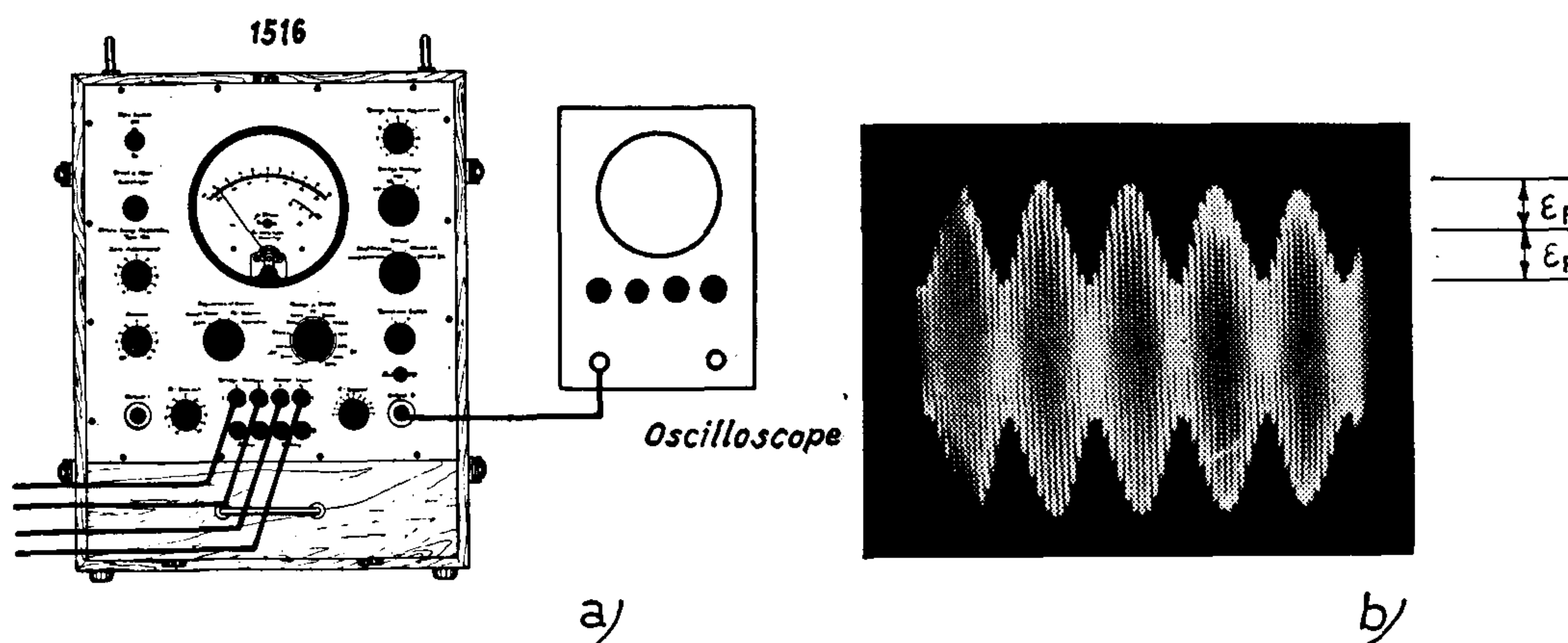

Fig. 18. a) Recording set-up using an oscilloscope.
b) Typical signal obtained.

the dynamic strain frequency being imposed upon the 3 kc/s carrier frequency of the Strain Gauge Apparatus.

The peak value of the strain, ϵ_p , is indicated on the figure.

3) When the frequency of the dynamic strain is higher than 200 c/s another type of measuring arrangement is necessary.

A suitable arrangement is shown in fig. 19a, employing a further accessory unit, namely the D. C. Bridge Supply Unit Type 1535. A photo of Type 1535 is shown in fig. 20.

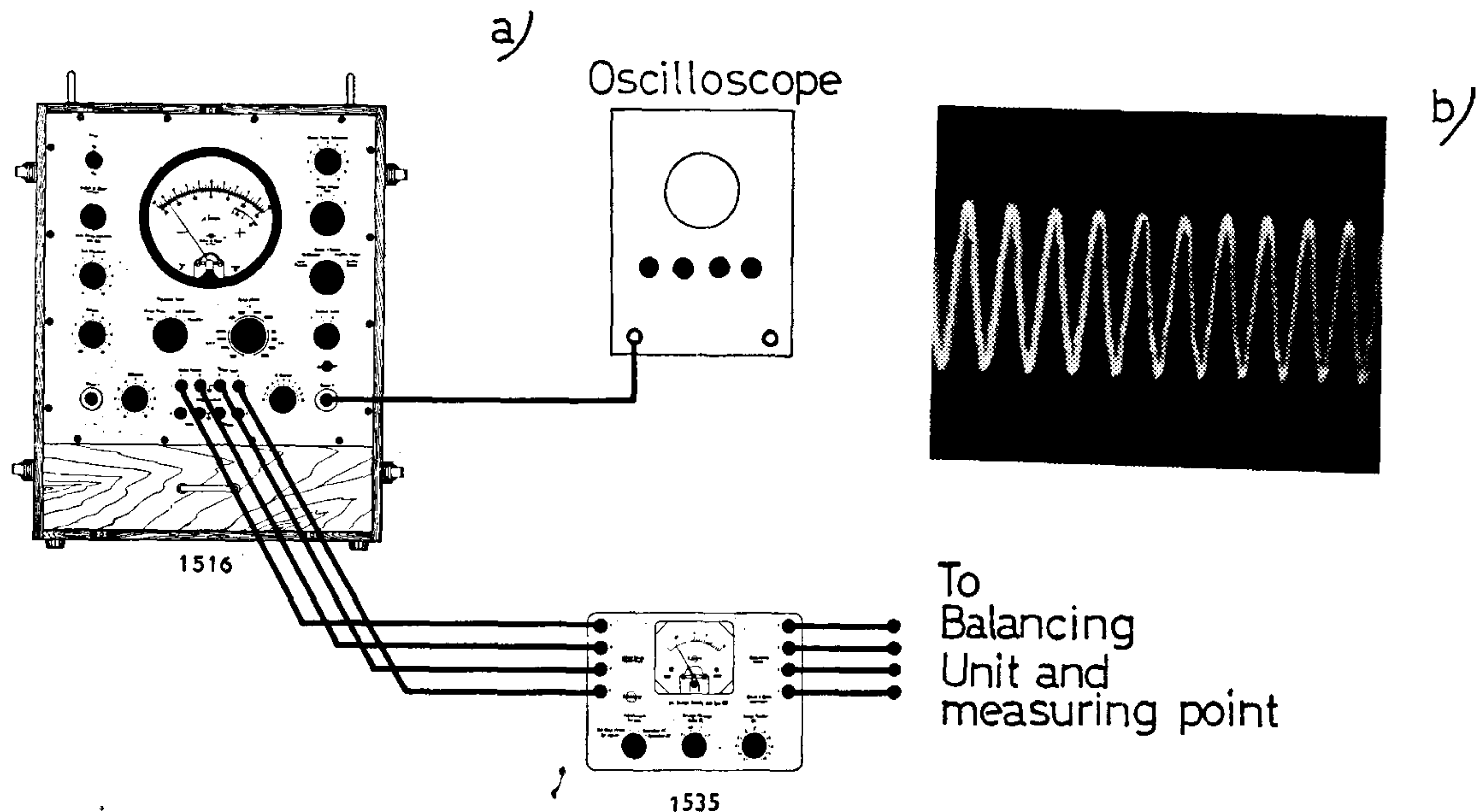

Fig. 19. Dynamic strain measurements at frequencies higher than 200 c/s, employing the D. C. Bridge Supply Unit Type 1535.

a) Measuring arrangement.

b) The measured result is displayed on the screen of an oscilloscope.

The strain being measured may also in this case be displayed on the screen of an oscilloscope, see fig. 19b, or a frequency analysis of the strain can be carried out and recorded on the Level Recorder.

In both cases a direct calibration in μ -strain can be made by means of the Strain Gauge Apparatus.

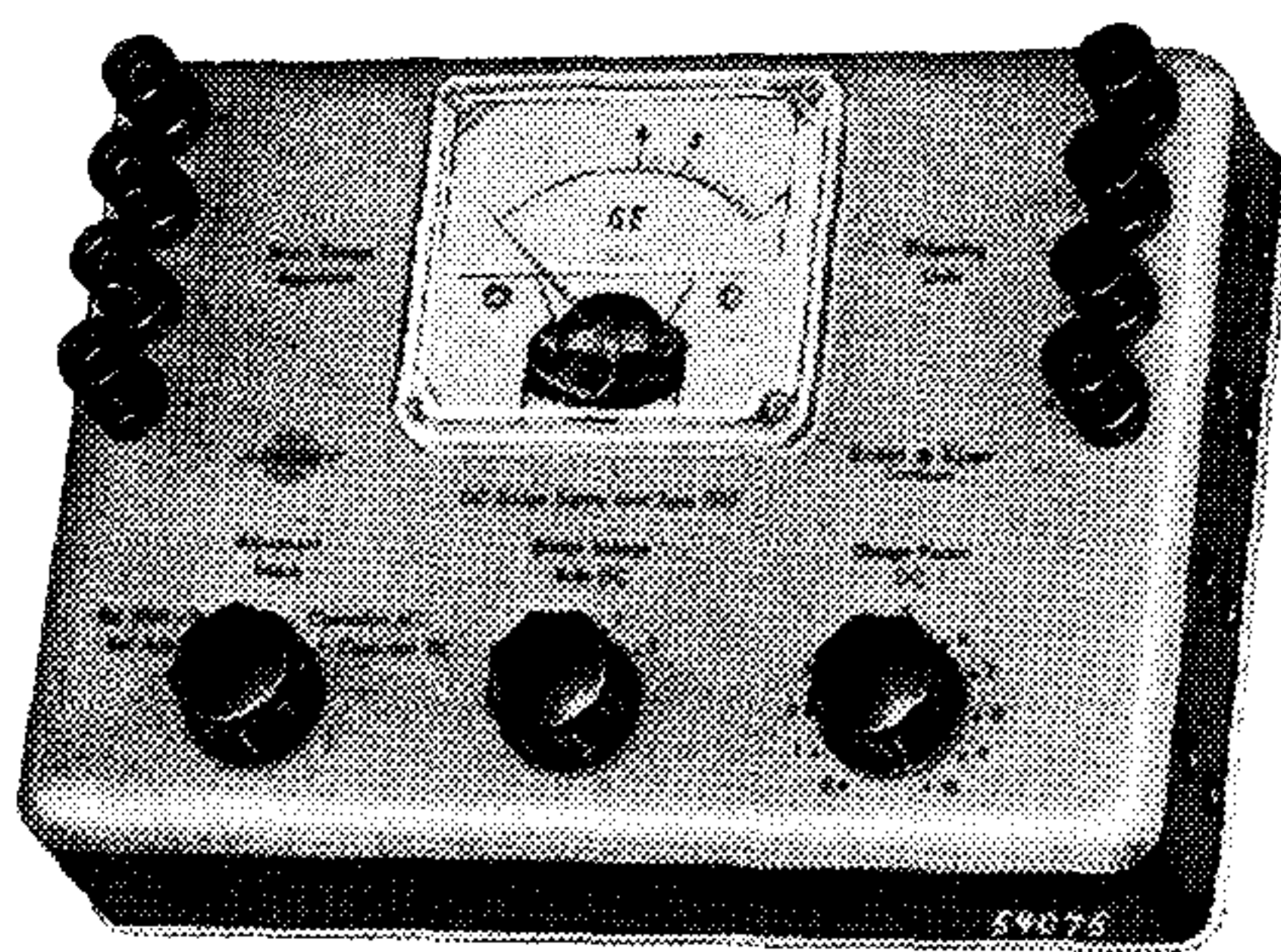

Fig. 20. Photo of the D. C. Bridge Supply Unit Type 1535.

In cases where it is desired to know the peak value of the strain in the material only the use of an oscilloscope as indicating instrument is advantageous.

However, where complicated stress wave shapes, or dynamic stress forces with continuous frequency spectra are being investigated the use of Audio Frequency Spectrum Recorder Type 2311 offers many advantages.

Fig. 21 shows a measuring arrangement suitable for frequency analysis of dynamic strain, and the result of an analysis of strain occurring in a bar hammering on a plate at a frequency of 90 c/s is shown in fig. 22.

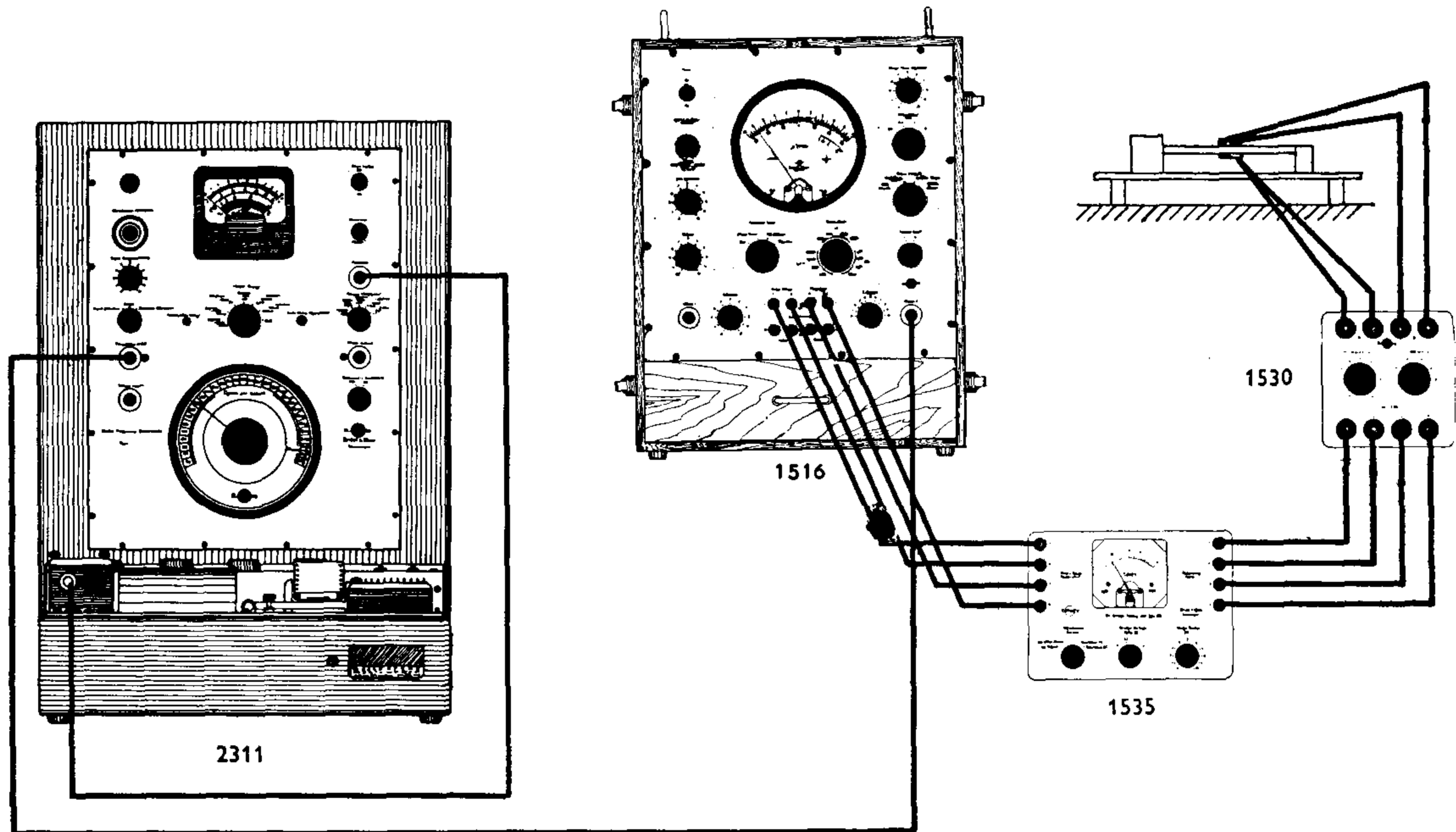

Fig. 21. Measuring arrangement suitable for frequency analysis of dynamic strain.

By means of the Spectrum Recorder Type 2311, which consists of a selective audio frequency amplifier and a level recorder of the Type 2304 a spectrogram as shown in fig. 22 can be taken automatically.

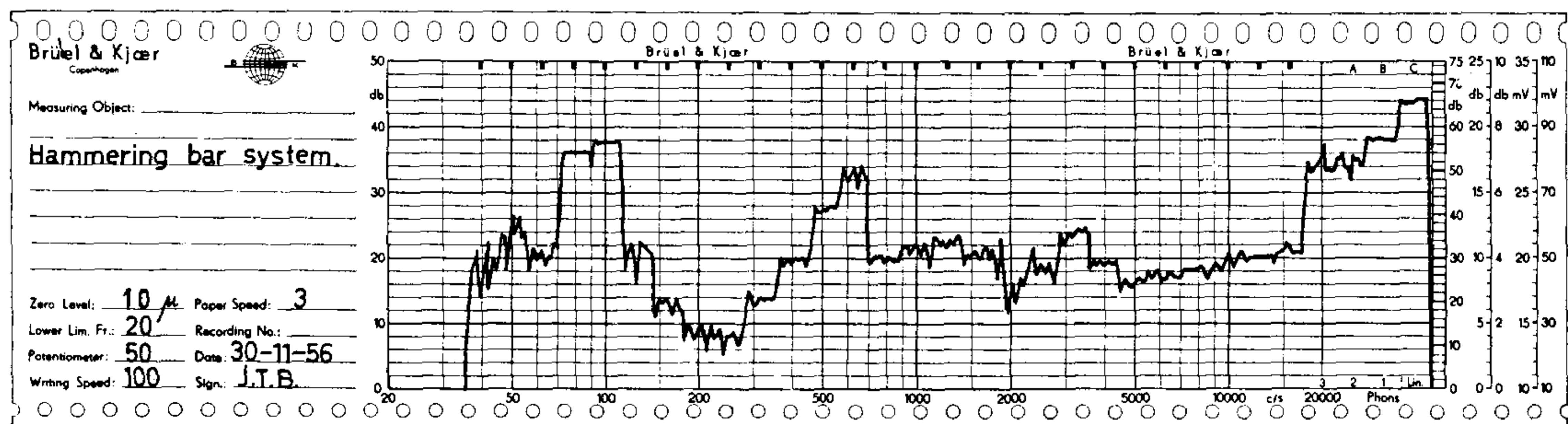

Fig. 22. Spectrogram obtained from measurements on a hammering bar system.

This is possible because the frequency sweep of the selective amplifier can be mechanically coupled to the motor drive in the Level Recorder and a synchronised drive to the pre-printed, frequency calibrated recording paper obtained.

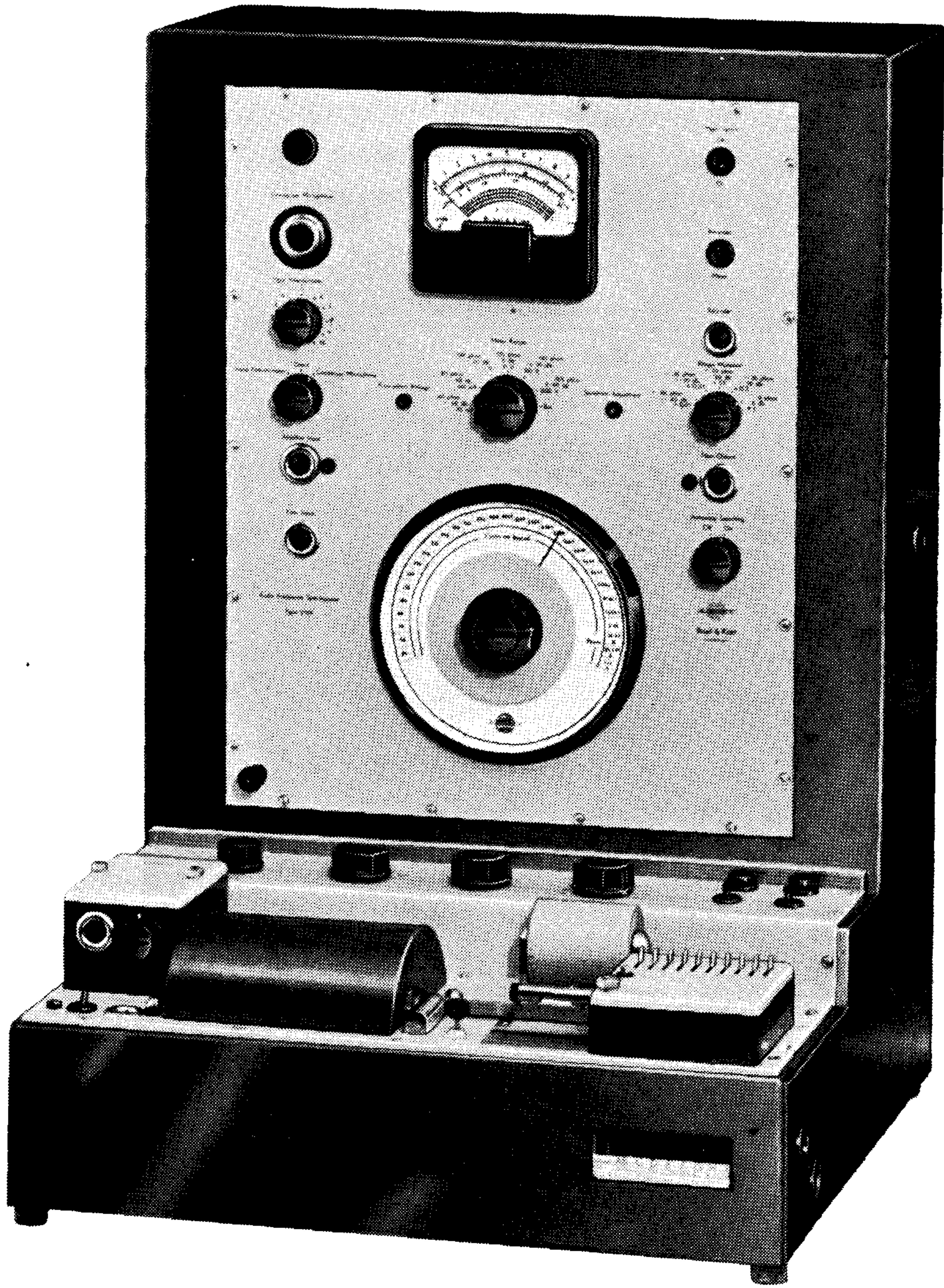

Fig. 23. Photo of the Audio Frequency Spectrum Recorder Type 2311.

A photo of the Audio Frequency Spectrum Recorder is shown in fig. 23. The highest frequency at which dynamic strain measurements can be taken is set by one of two factors.

a) The active gauge length. It is necessary that this length be short compared with the wave length of the vibration being measured. A fair value of the ratio gauge length to wave length is 1:10.

b) The high frequency cut-off of the measuring amplifier.

A typical frequency characteristic of the amplifier in the Strain Gauge Apparatus Type 1516 is shown in fig. 24, and a simple calculation will show that the limiting factor b) is chosen to suit the limiting factor a):

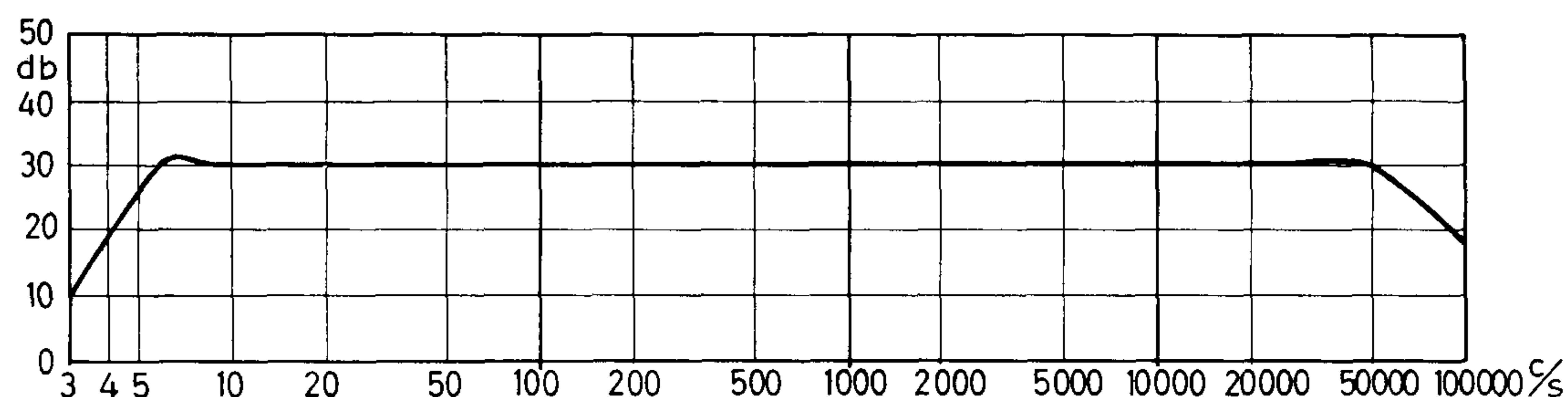

Fig. 24. Typical frequency characteristic of the amplifier in the Strain Gauge Apparatus Type 1516 when switched to "Amplifier Output".

If the velocity of sound in metal is taken to be approx. 5 000 metres/sec, the frequency limit 50 kc/s corresponds to a wave length of:

$$\lambda = \frac{5 \cdot 10^3}{50 \cdot 10^3} = 0.1 \text{ metres} = 10 \text{ cm}$$

This means that only with strain gauges having an effective length of 1 cm the frequency response of the amplifier can be fully utilized.

Finally it should be mentioned that a further output facility of the Strain Gauge Apparatus makes possible the use of a pen recorder, i. e. the Brush Oscillograph Type BL 201. This oscillograph should be used in connection with a suitable d. c. amplifier whereby it is possible to record dynamic strain variations up to frequencies around 100 c/s on curve-linear recording paper. An example is shown in fig. 25.

Up to this point the discussion has been mainly concerned with strain measurements to determine the stresses in structures.

There is, however, another important field of application for strain gauges and strain gauge equipment. This is in the field of indirect measurement where strain gauges are built into mechanical transducing devices which transfer various physical phenomena into strains. Temperature, pressure.

fluid flow, weight and transmitted horse power may all be measured in this manner. Suitable design of such units permits the utilization of four active gauges and full temperature compensation. In fig. 26a a weighing system with four active gauges is shown, and in fig. 26b the connection of the gauges to form a bridge is indicated.

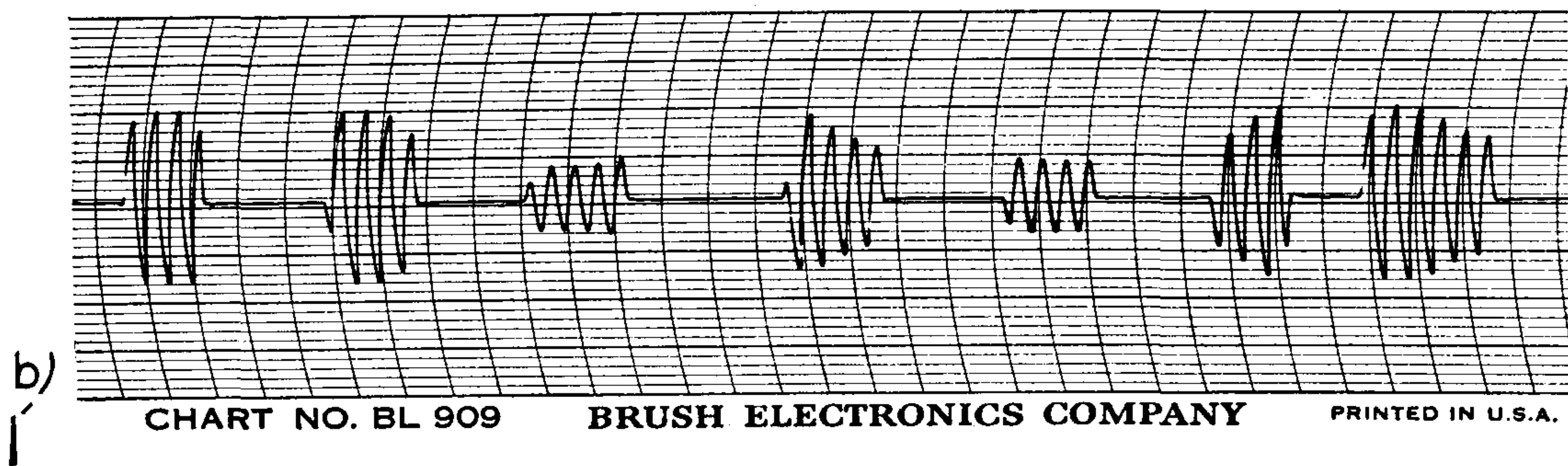
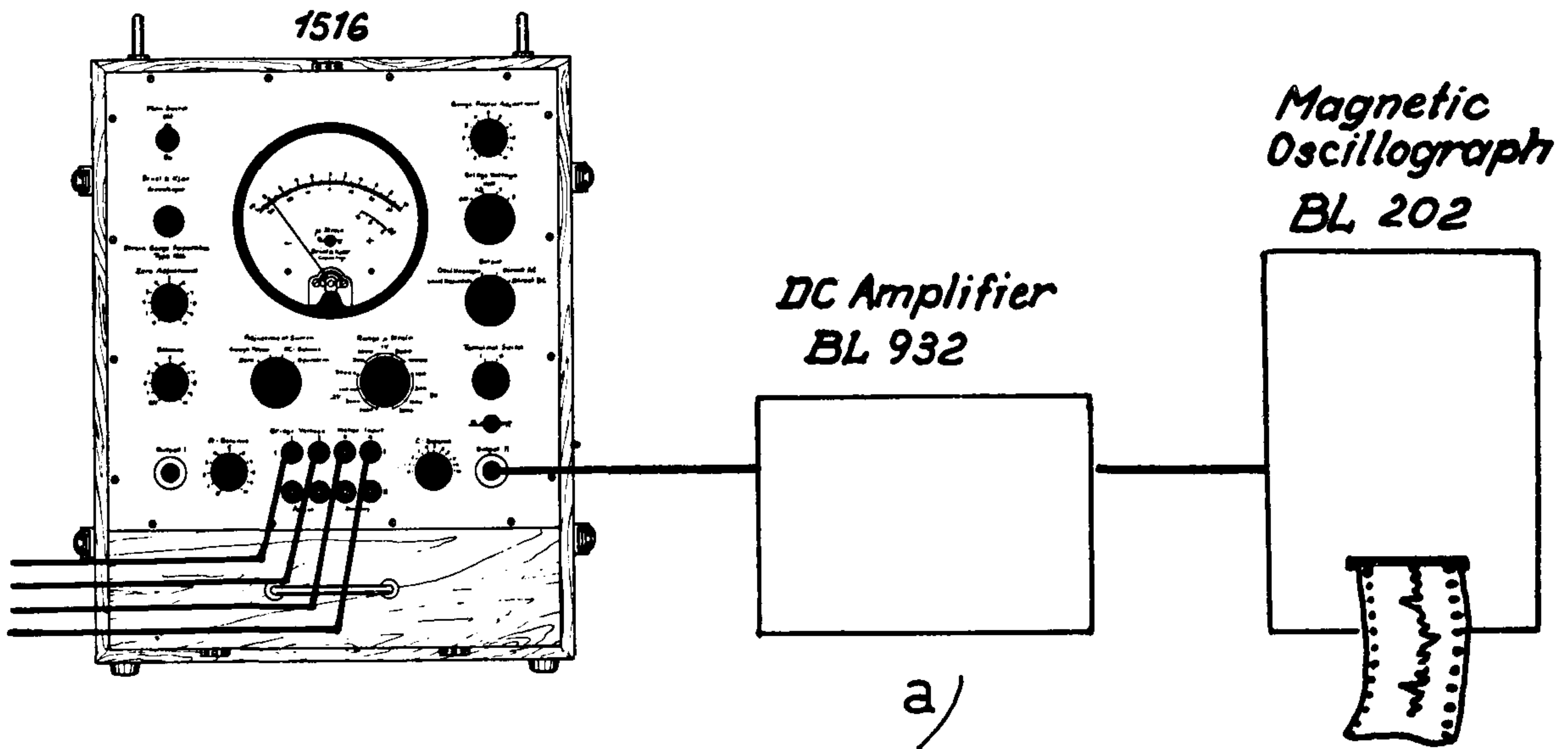

Fig. 25. Recording of dynamic measurements by means of a magnetic oscillograph.

- a) Measuring arrangement.
- b) Typical oscillogram.

When used in such a measuring set-up the max. sensitivity of the Strain Gauge Apparatus Type 1516 is $25 \mu\text{-strain}$ ($25 \cdot 10^{-6} \text{ mm/mm}$) for full deflection on the instrument meter.

The Strain Gauge Apparatus is extremely versatile, and in the foregoing only a few typical examples of application and prospects of the instrument have been described.

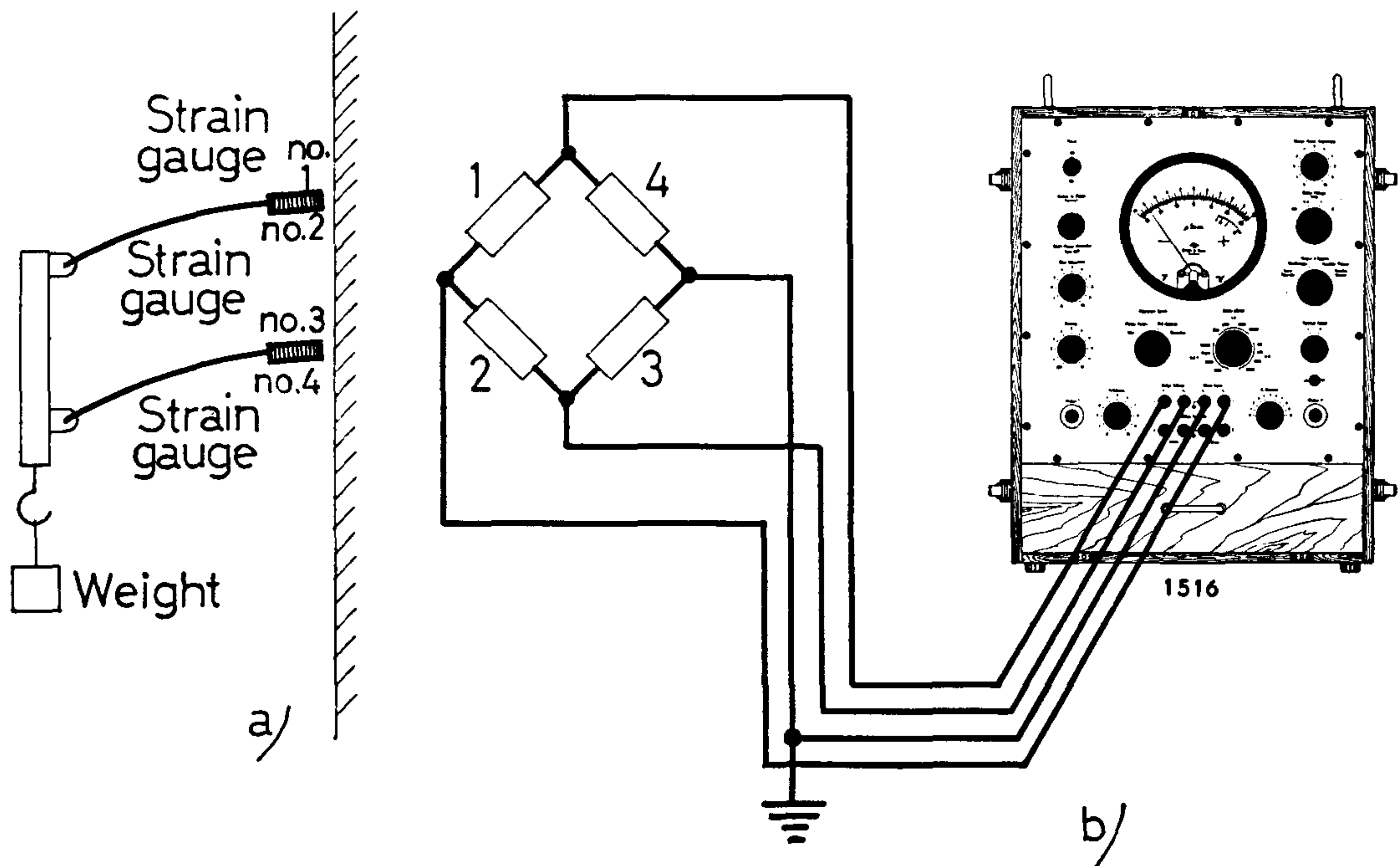
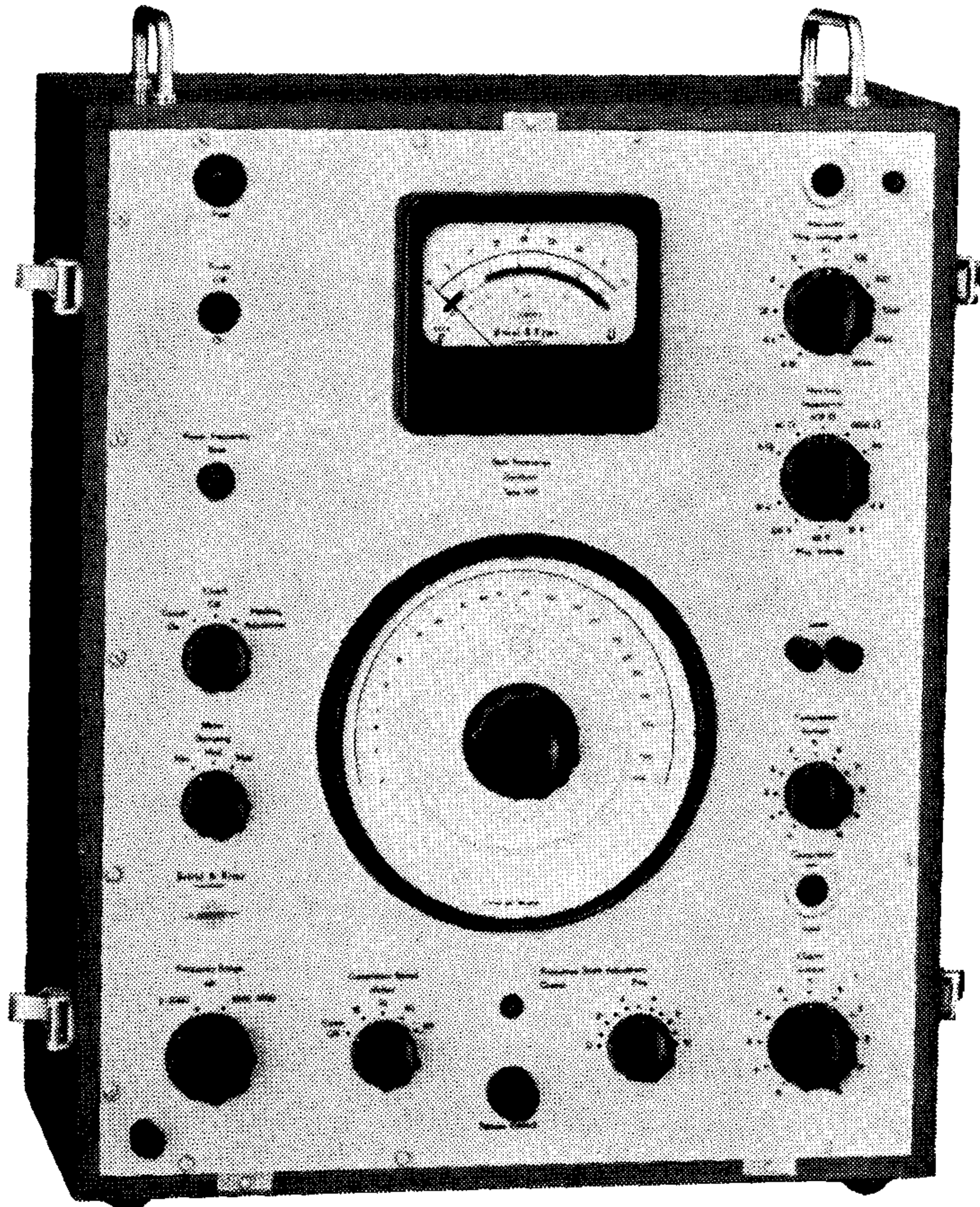

Fig. 26. Mechanical weighing arrangement employing resistance strain gauges.
 a) Mechanical arrangement.
 b) Strain Gauge connection.

The use of strain gauges in testing of aircraft, ships and cars is fully established as it is in the field of structures, bridge, road and dam building and the like. In fact there are few industries or enterprises, where strength and weight are important features, that strain gauging is not being introduced. In many cases the large safety-margins used in the construction of complicated machinery may be reduced considerably. The size and weight of modern machinery is as a result often only half, or less of what it would have been 20 years ago, and a proper use of strain gauge measurements can save both material and much of the time spent on difficult calculations.

News from the Factory:



Type 1015.

Low Frequency B. F. O. Type 1015.

A new beat frequency oscillator covering the frequency range 2 c/s to 2000 c/s, with an additional frequency range from 2002 to 4000 c/s is now in production. The frequency scale is logarithmic from 2 c/s to 2000 c/s. Similar to the B. F. O. Type 1014, Type 1015 contains an automatic output control (compressor) circuit with variable compressor speed, different output facilities and a calibrated V. T. voltmeter.

The meter damping of the V. T. voltmeter is variable.

Max. available output power is approx. 2 watts in 6000 Ω , and the distortion is smaller than 0.5 % at 100 c/s with a load of 1 watt.

Furthermore, automatic frequency sweep from external motor drive possible. Electro-magnetic clutch arrangement.

The B.F.O. Type 1015 is designed for use in electrical and electro-mechanical research and production work and is delivered in mahogany cabinet.

Beat Frequency Oscillator Type 1035.

This Type No. covers an oscillator of the type 1015. However, the oscillator is delivered in Steel Cabinet with flange for 19" rack mounting.

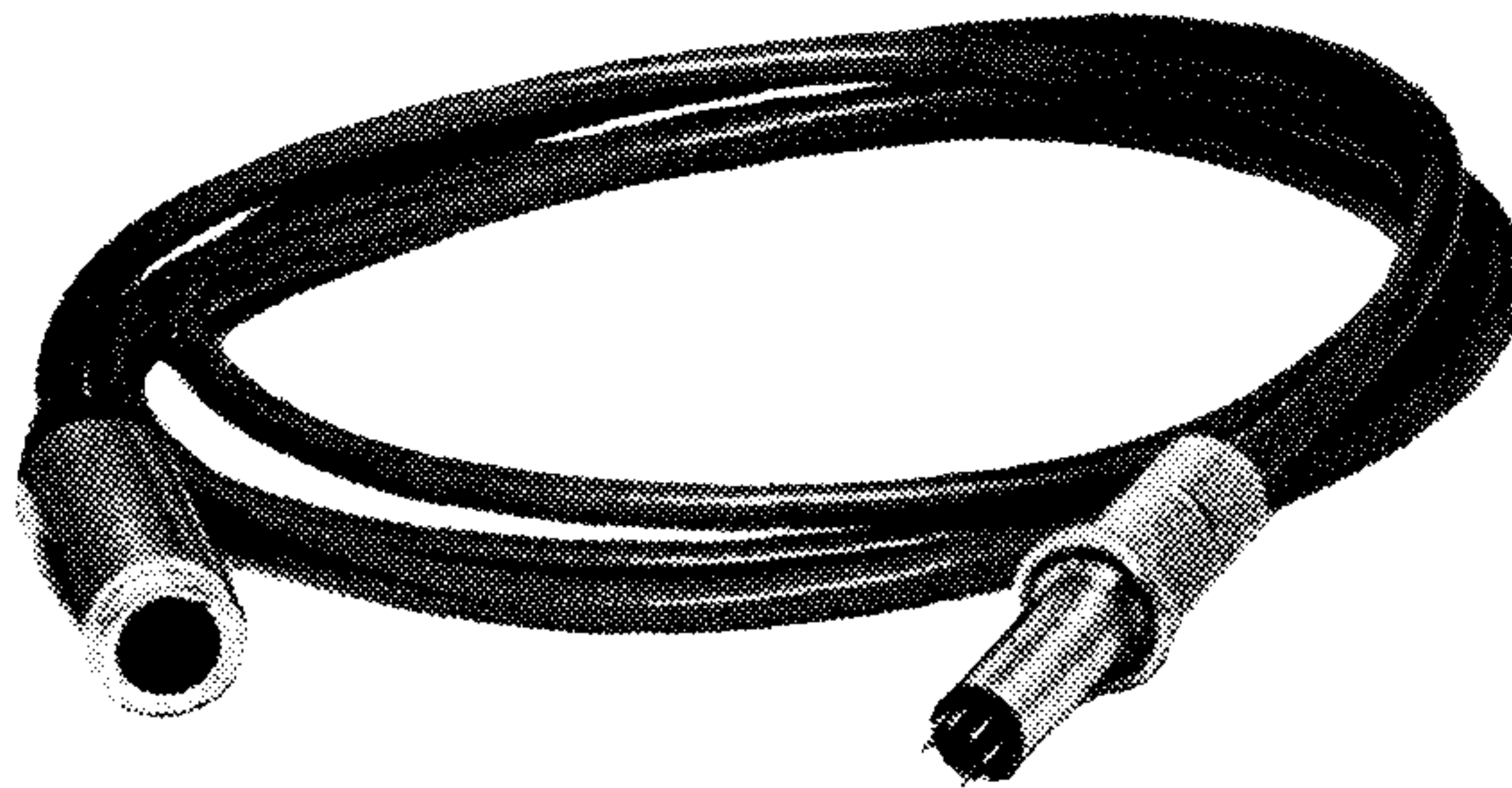

Type AO 0040 and AO 0041.

Extension Cable Type AO 0040 and AO 0041.

Multicore cables for use in conjunction with the Condenser Microphone Type 4111. Length 3 and 10 m respectively. Type AO 0041 replaces the Extension Cable Type 4114.

Piezo-Electric Vibration Pick-ups Type 4303 and 4305.

The introduction of the Barium Titanate Accelerometer Sets Type 4308 and 4309 and the Accelerometer Packages Type 4348 and 4349 has made the Vibration Pick-ups Type 4303 and 4305 superfluous and these items have therefore been taken out of production.

Short Catalog.

A new edition of the B & K Short Catalog containing information on all the instruments and accessories in production medio December 1956 is now available.



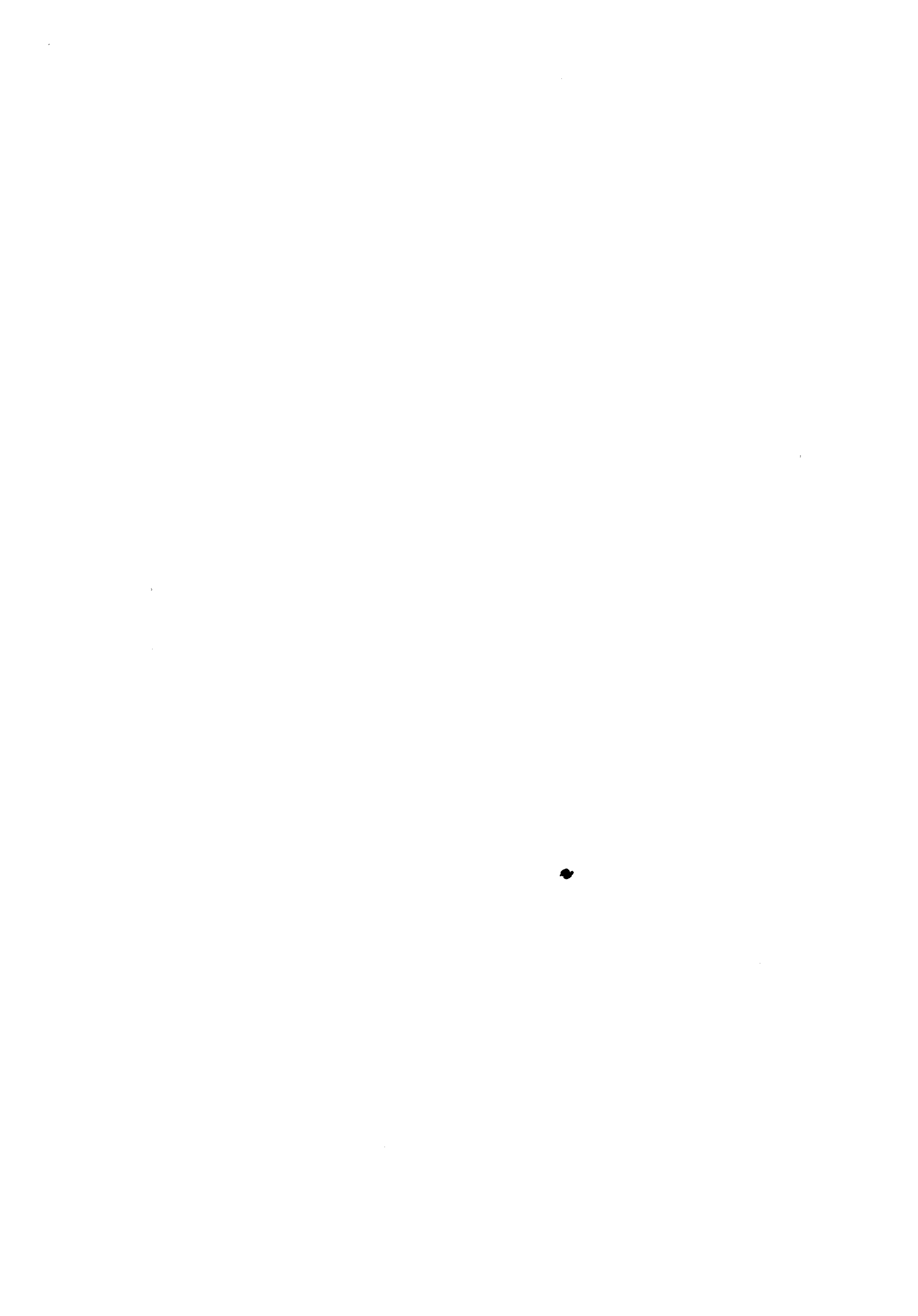

Brüel & Kjær

ADR.: BRÜEL & KJÆR
NÆRUM - DENMARK



TELEPHONE: 80 05 00
⚡ BRUKJA, Copenhagen

Printed in Copenhagen, Denmark